

STATE OF OHIO - DEPARTMENT OF TRANSPORTATION

STATE ROUTE SECTIONS ON CONTINUOUS MILEAGE STATIONING

DISTRICT	8
COUNTY	HAMILTON
ROUTE	IR 275

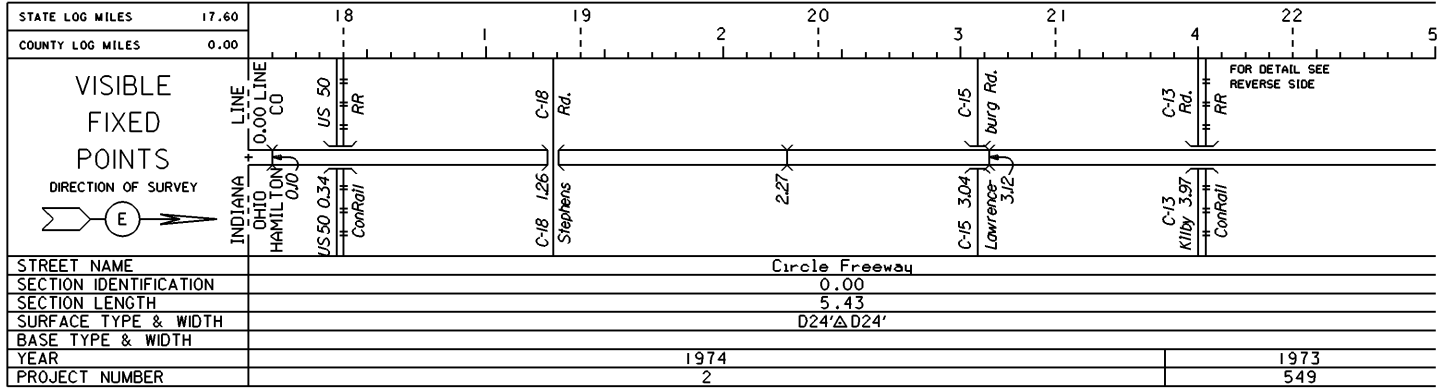

PERPETUATION

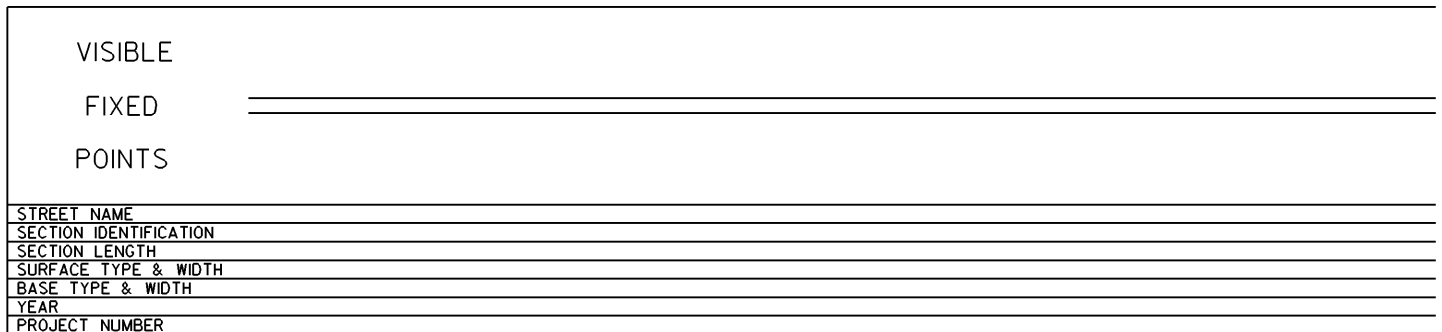
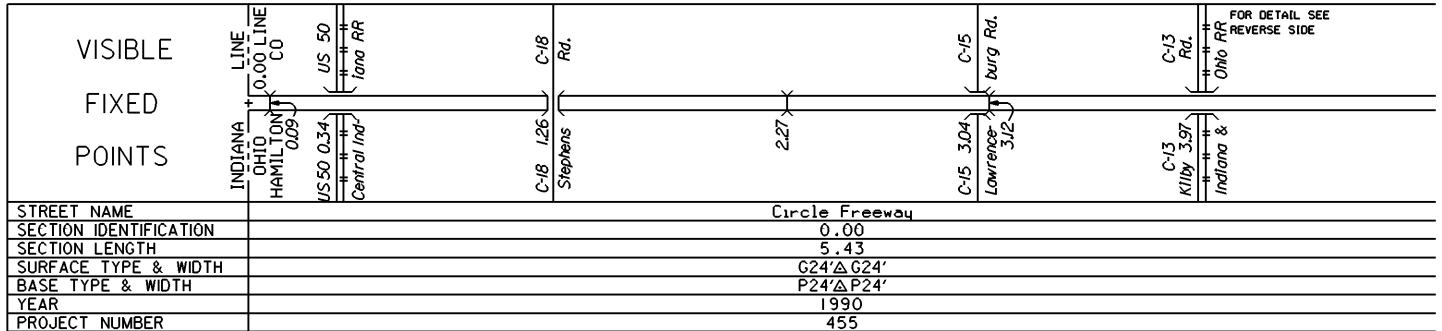

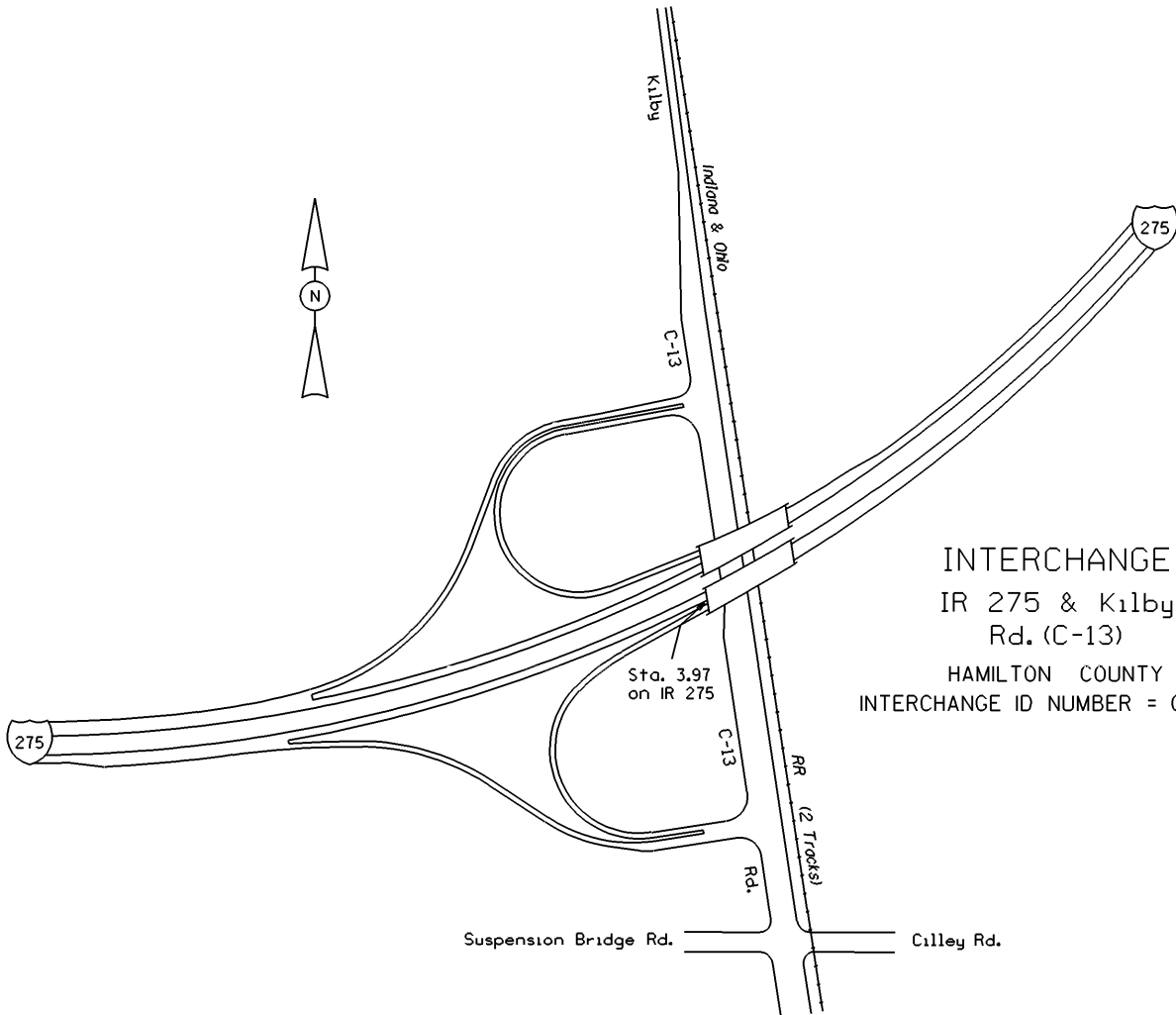

INTERCHANGE
IR 275 & Kilby
Rd. (C-13)

HAMILTON COUNTY
INTERCHANGE ID NUMBER = 042200

STATE OF OHIO - DEPARTMENT OF TRANSPORTATION
STATE ROUTE SECTIONS ON CONTINUOUS MILEAGE STATIONING

DISTRICT 8
COUNTY HAMILTON
ROUTE IR 275

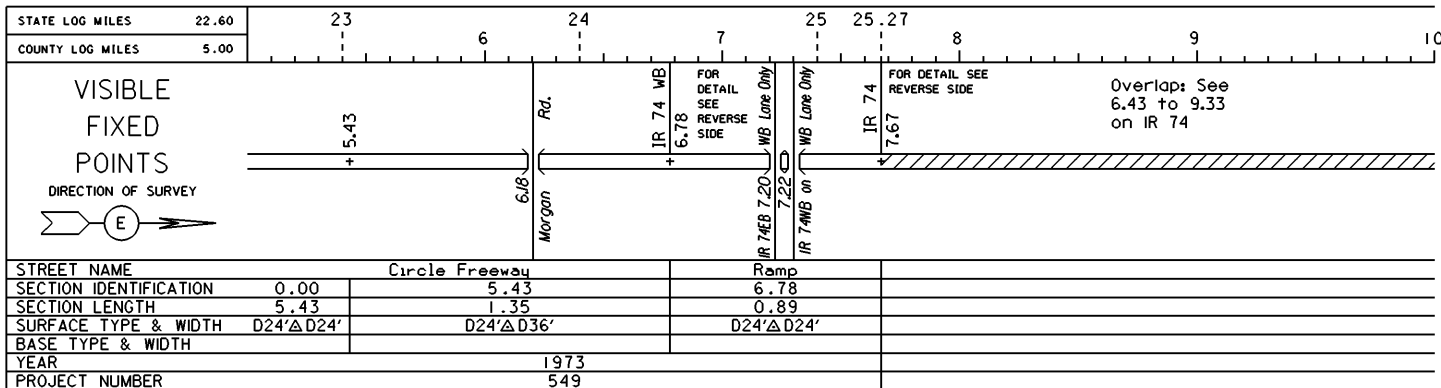

PERPETUATION

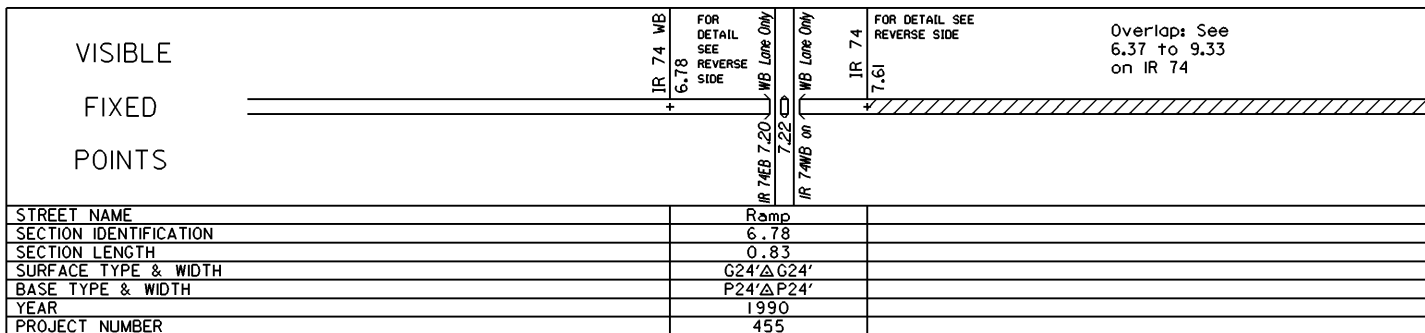
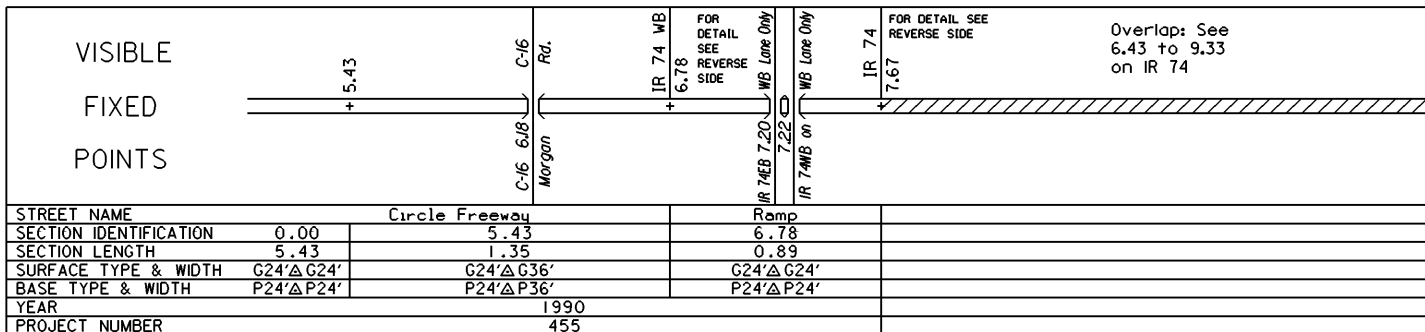

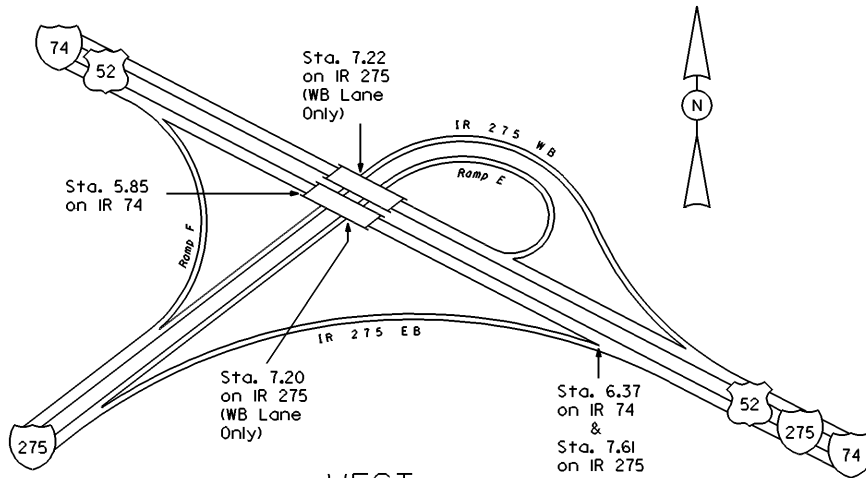

WEST
 INTERCHANGE
 IRs 74, 275 & US 52
 HAMILTON COUNTY
 INTERCHANGE ID NUMBER = 040100

STATE OF OHIO - DEPARTMENT OF TRANSPORTATION

STATE ROUTE SECTIONS ON CONTINUOUS MILEAGE STATIONING

DISTRICT 8
 COUNTY HAMILTON
 ROUTE IR 275

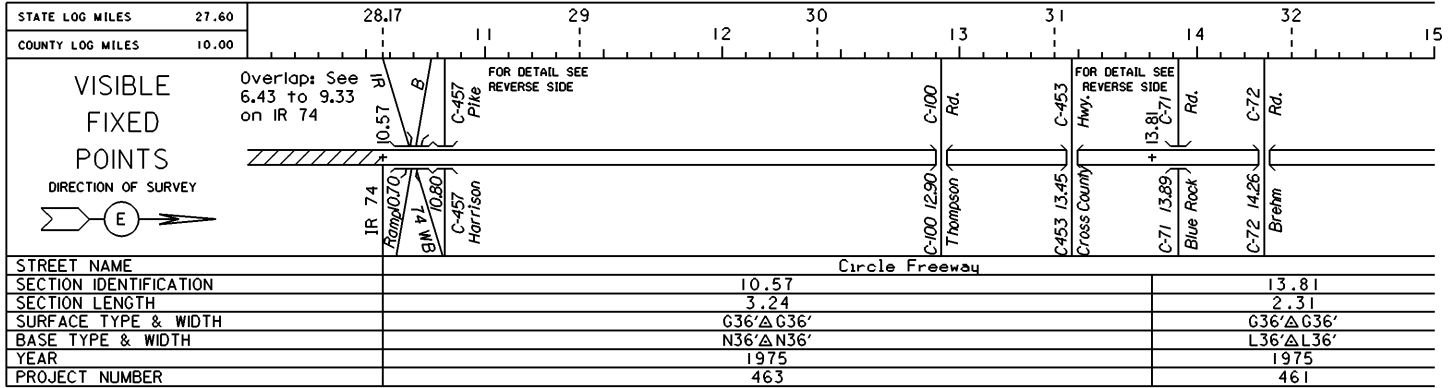

PERPETUATION

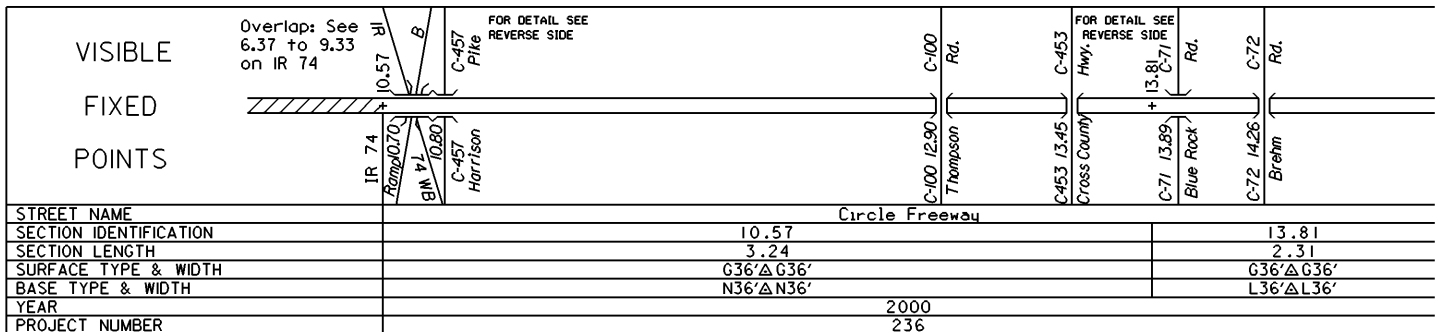
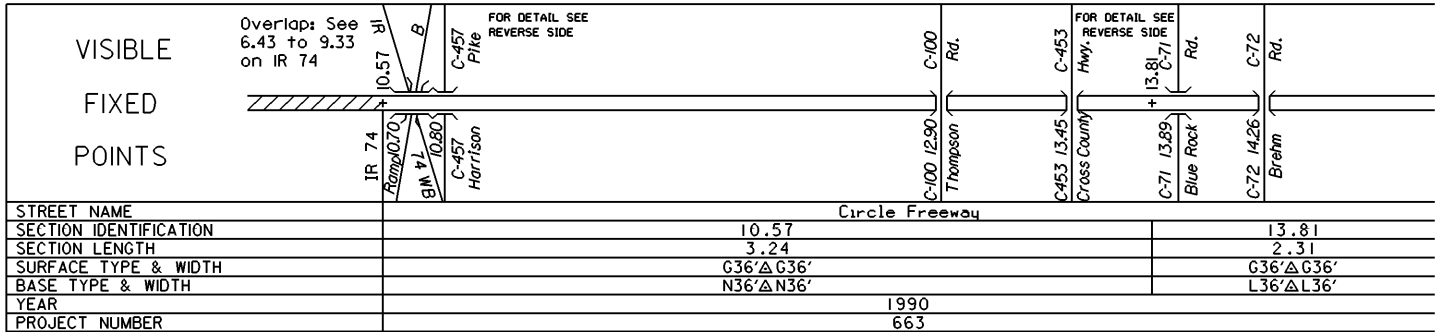

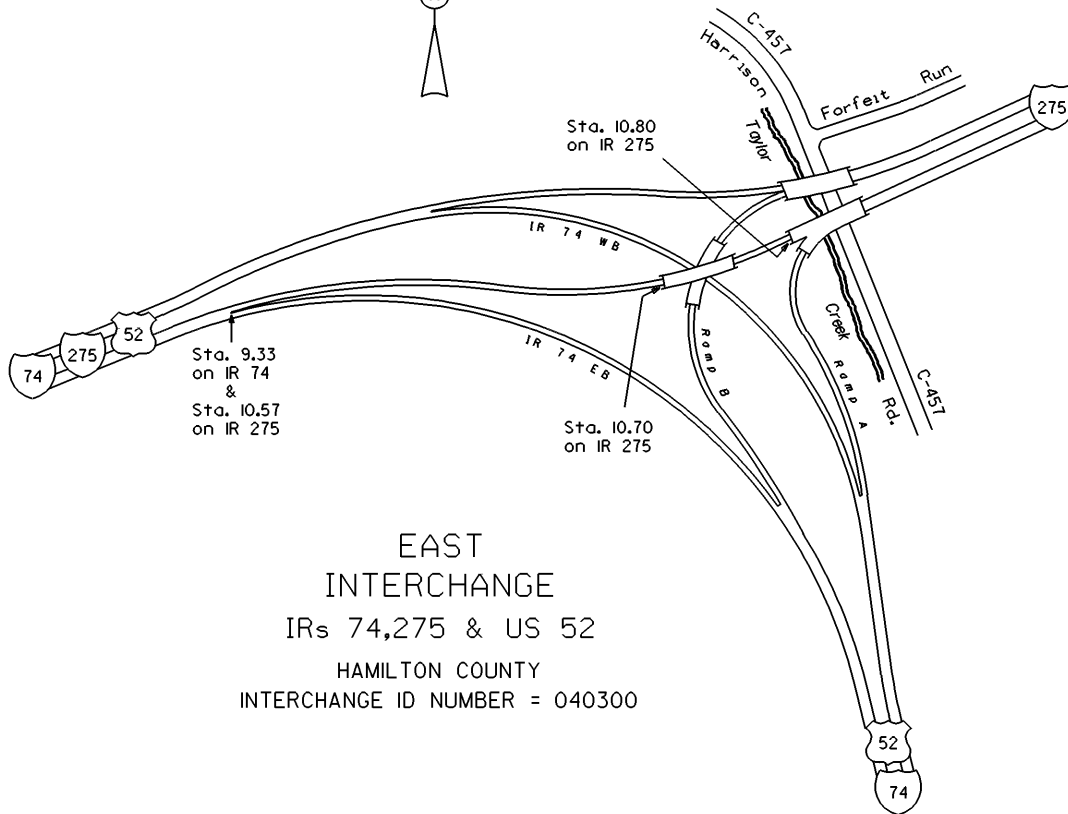

EAST
INTERCHANGE
IRs 74,275 & US 52
HAMILTON COUNTY
INTERCHANGE ID NUMBER = 040300



INTERCHANGE
IR 275 & Cross
County Hwy. (C-453)
HAMILTON COUNTY
INTERCHANGE ID NUMBER = 042300

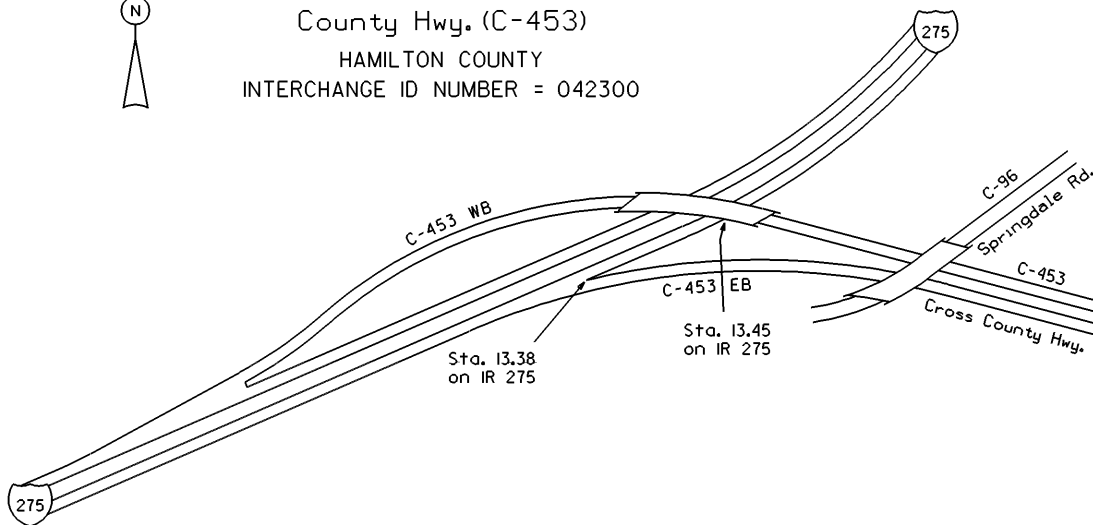

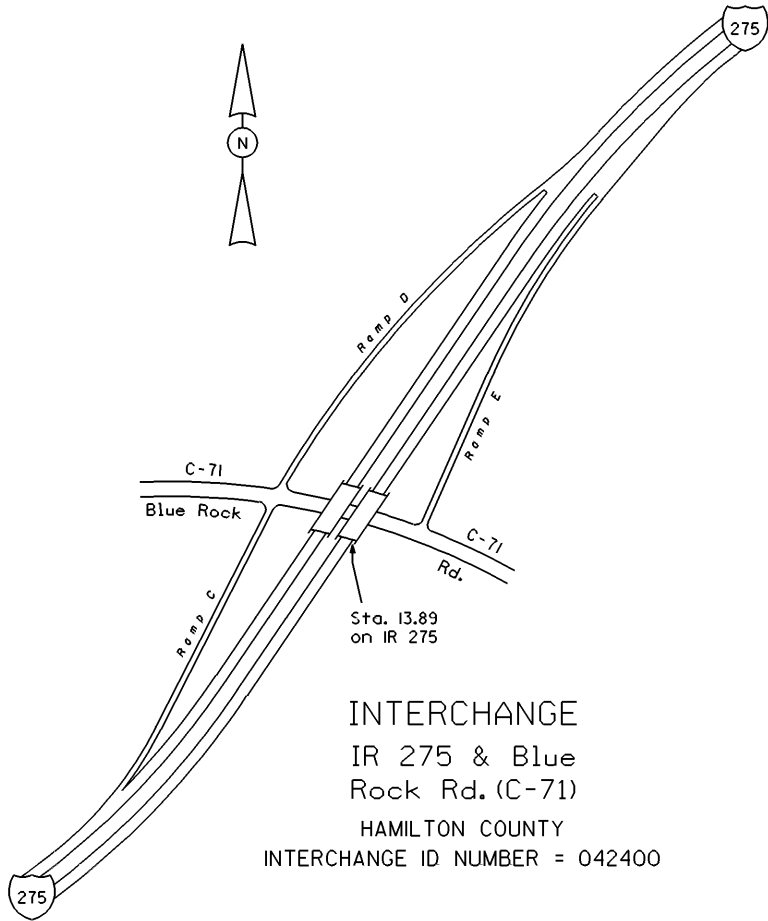

INTERCHANGE
IR 275 & Blue
Rock Rd. (C-71)
HAMILTON COUNTY
INTERCHANGE ID NUMBER = 042400

STATE OF OHIO - DEPARTMENT OF TRANSPORTATION
STATE ROUTE SECTIONS ON CONTINUOUS MILEAGE STATIONING

DISTRICT 8
COUNTY HAMILTON
ROUTE IR 275

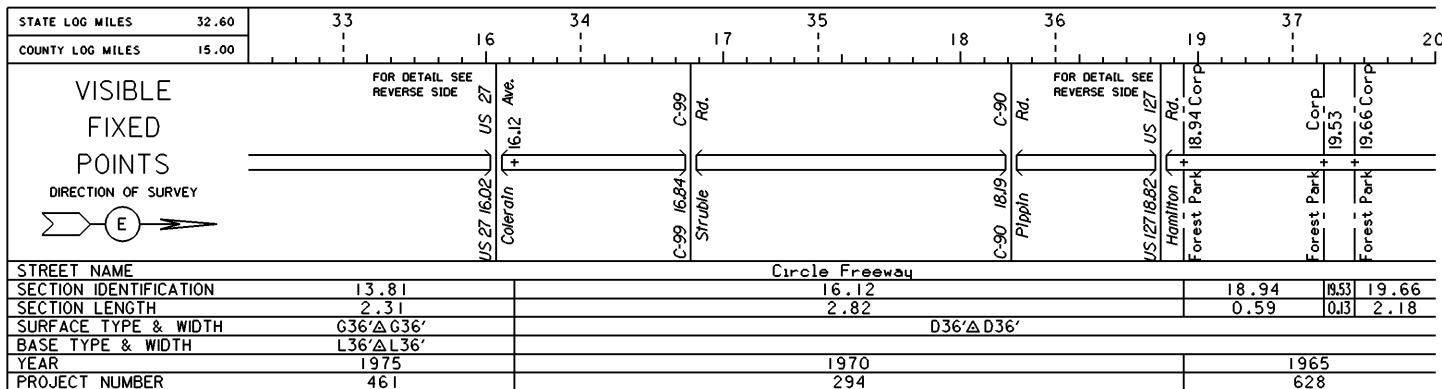

PERPETUATION

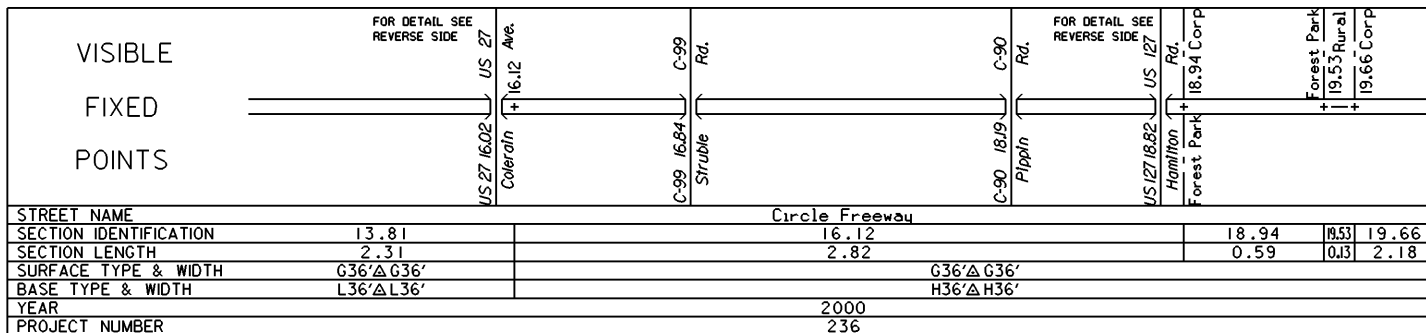
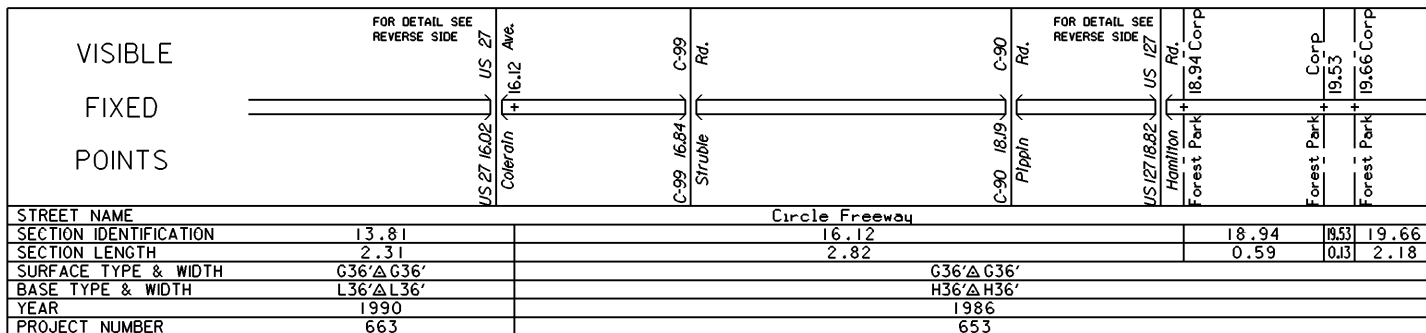

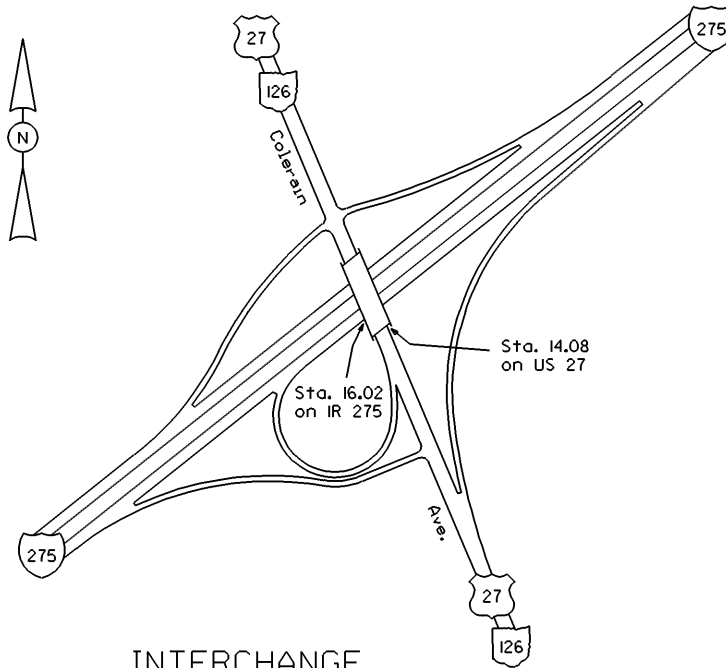

INTERCHANGE
IR 275, US 27 & SR 126
HAMILTON COUNTY
INTERCHANGE ID NUMBER = 042500

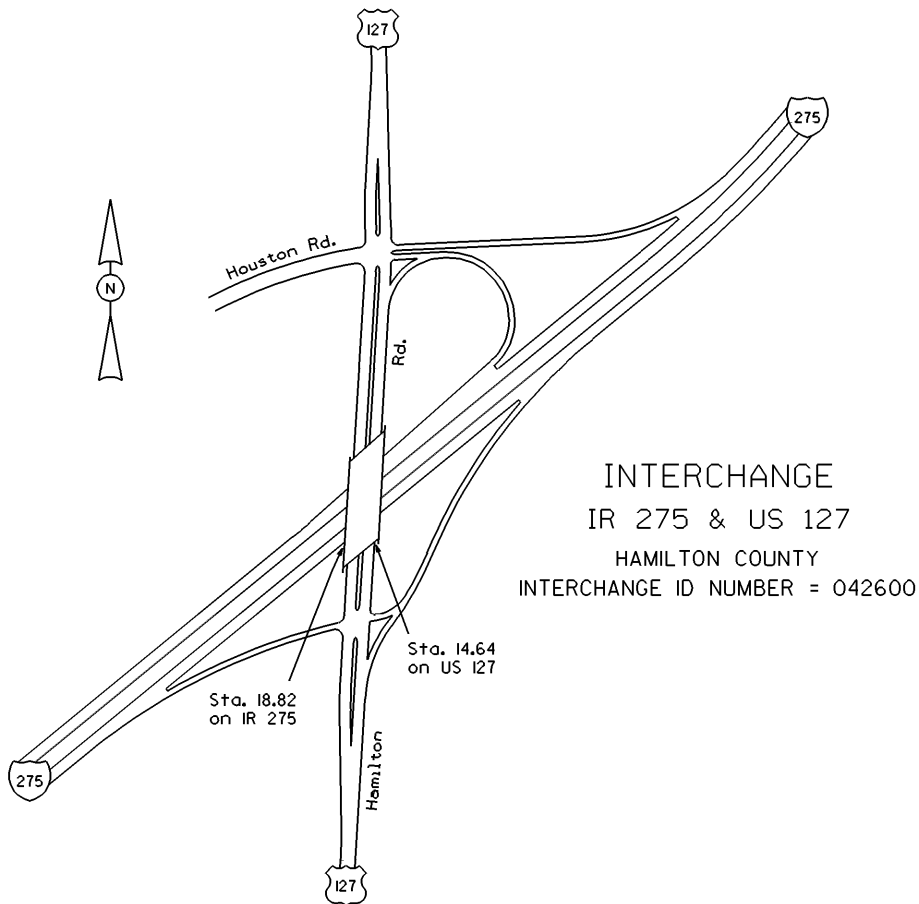

INTERCHANGE
IR 275 & US 127
HAMILTON COUNTY
INTERCHANGE ID NUMBER = 042600

STATE OF OHIO - DEPARTMENT OF TRANSPORTATION
STATE ROUTE SECTIONS ON CONTINUOUS MILEAGE STATIONING

DISTRICT 8
COUNTY HAMILTON
ROUTE IR 275

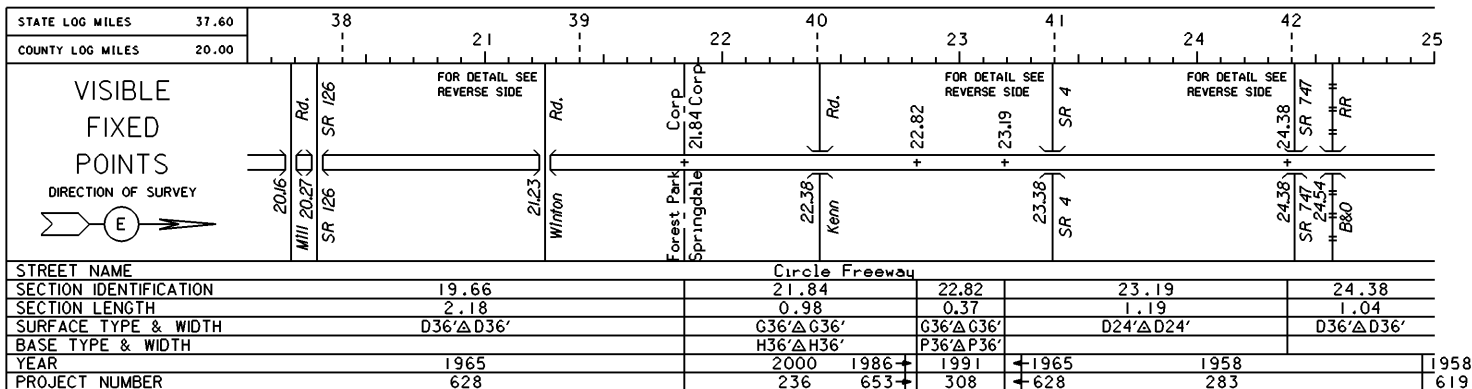

PERPETUATION

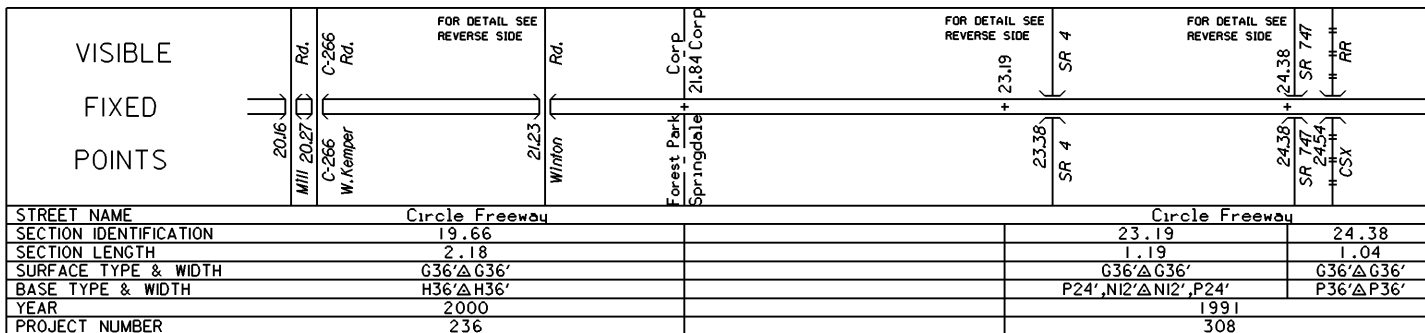
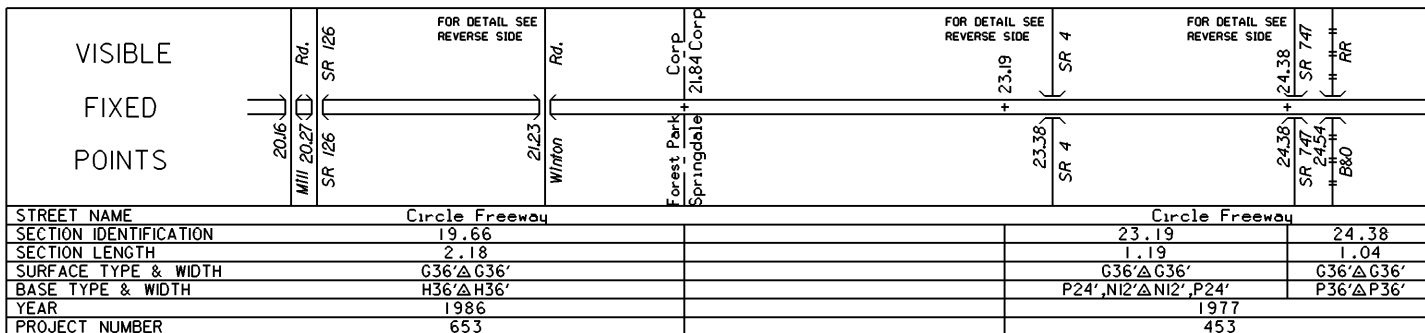

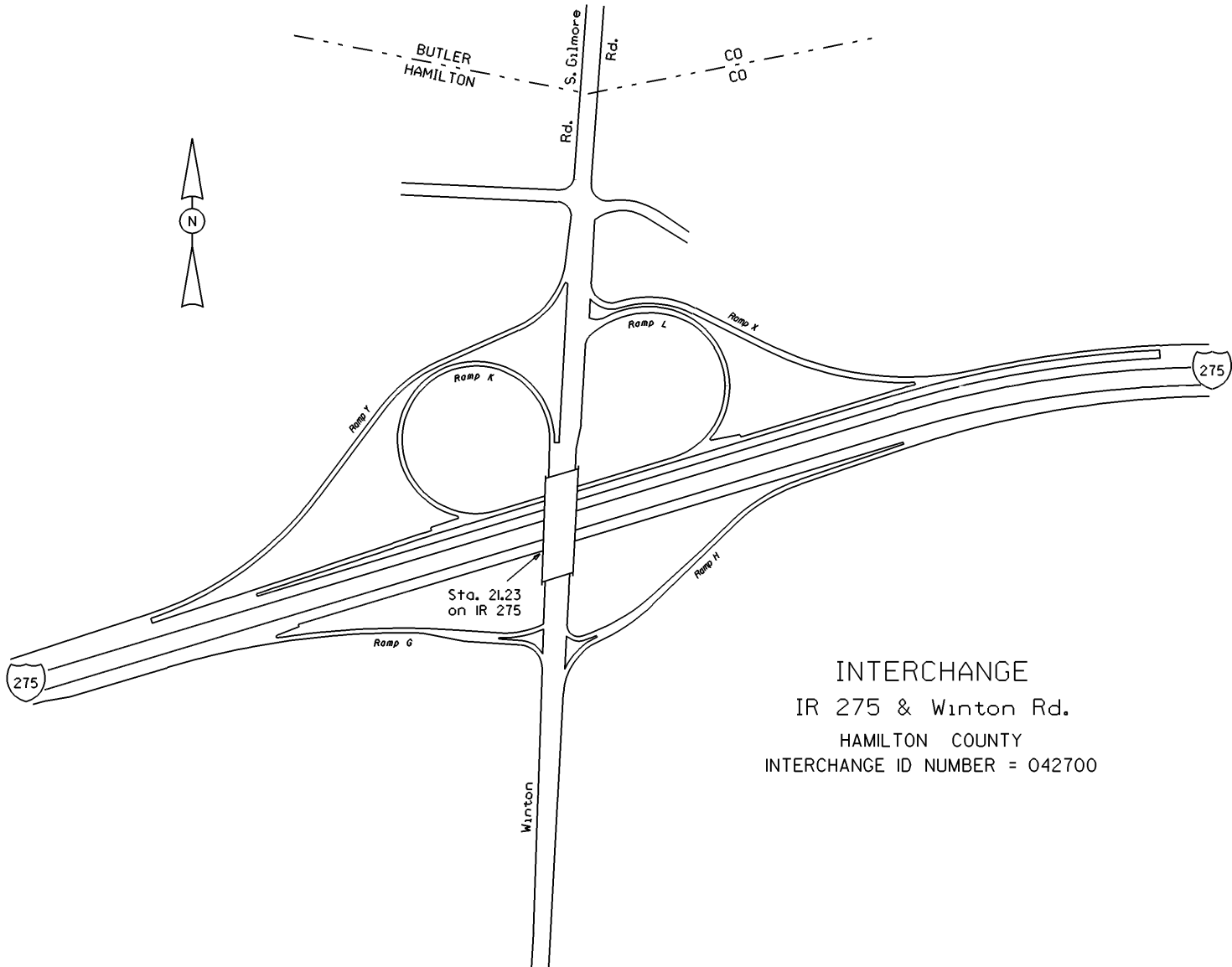

INTERCHANGE
IR 275 & Winton Rd.
HAMILTON COUNTY
INTERCHANGE ID NUMBER = 042700

INTERCHANGE
IR 275 & SR 4
HAMILTON COUNTY
INTERCHANGE ID NUMBER = 042800

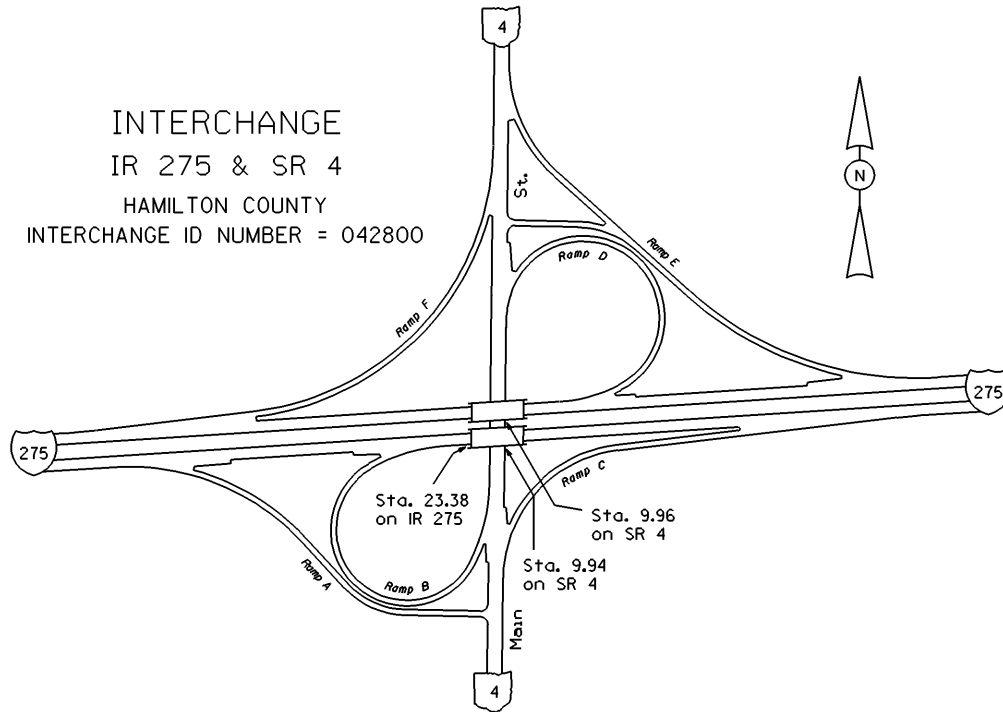



INTERCHANGE
IR 275 & SR 747
HAMILTON COUNTY
INTERCHANGE ID NUMBER = 042900

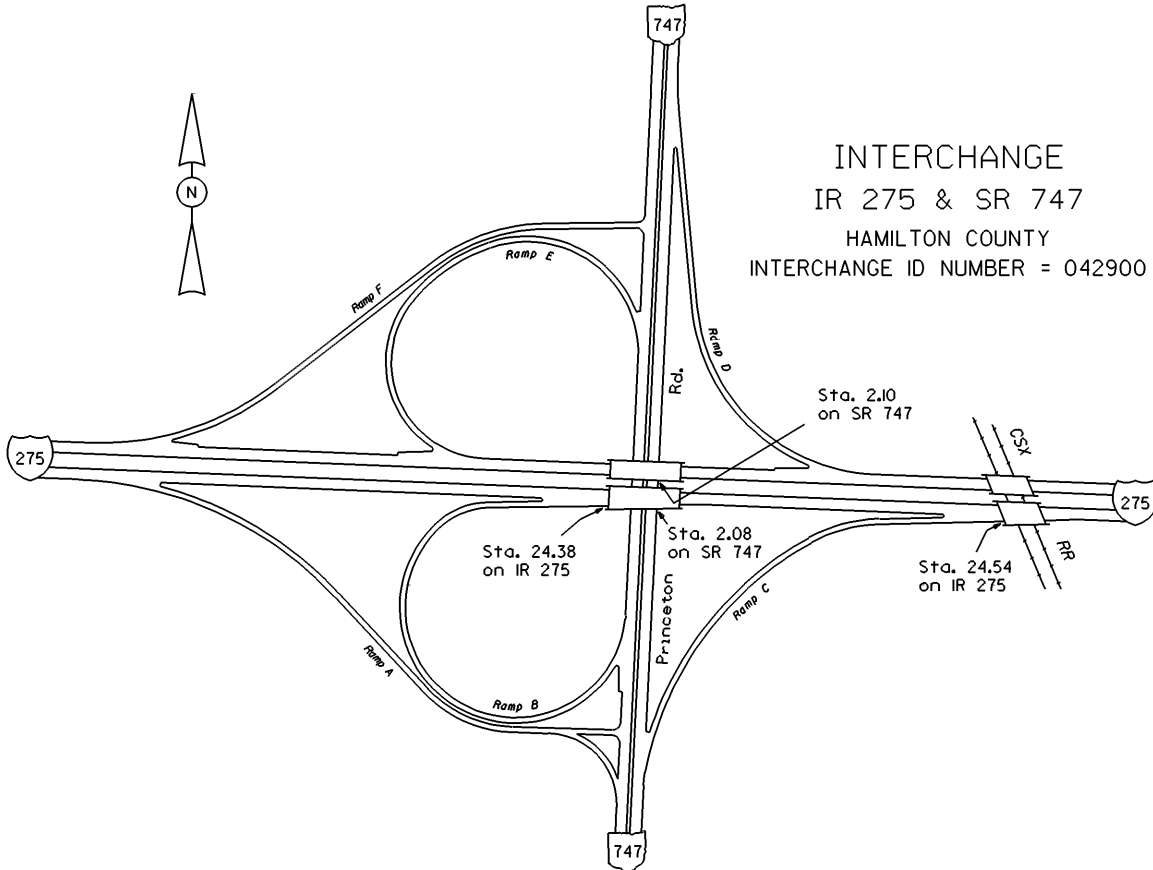

STATE OF OHIO - DEPARTMENT OF TRANSPORTATION

STATE ROUTE SECTIONS ON CONTINUOUS MILEAGE STATIONING

DISTRICT 8
COUNTY HAMILTON
ROUTE IR 275

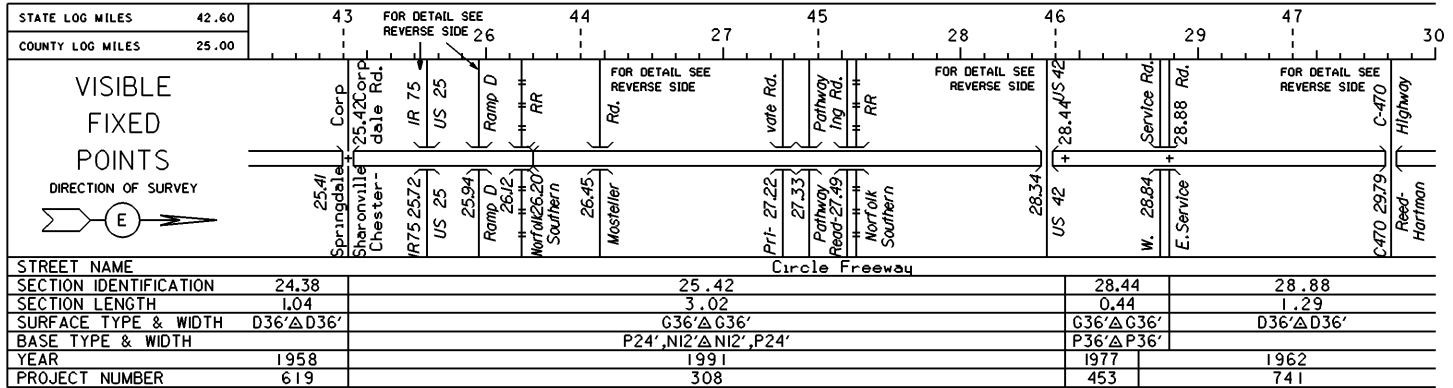

PERPETUATION

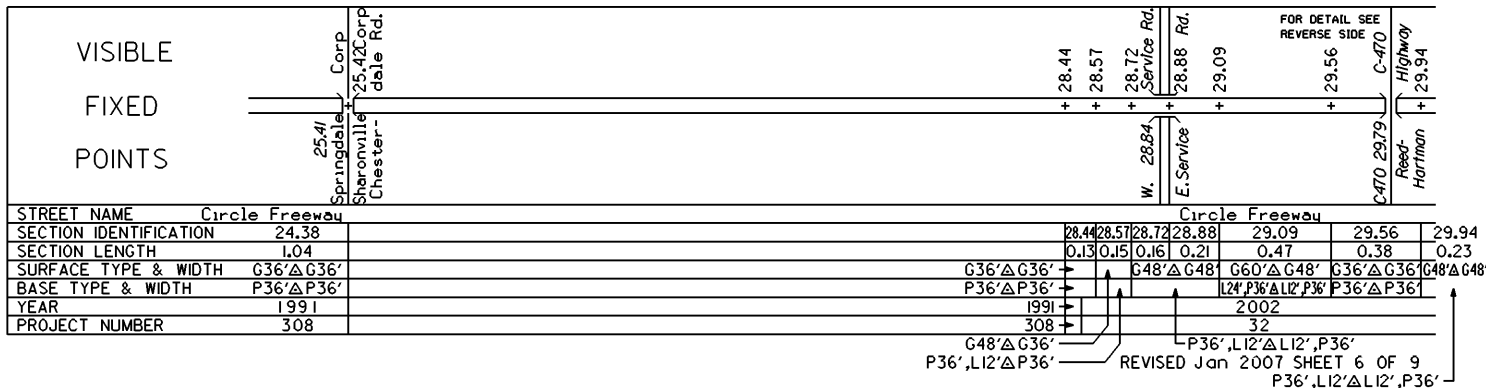
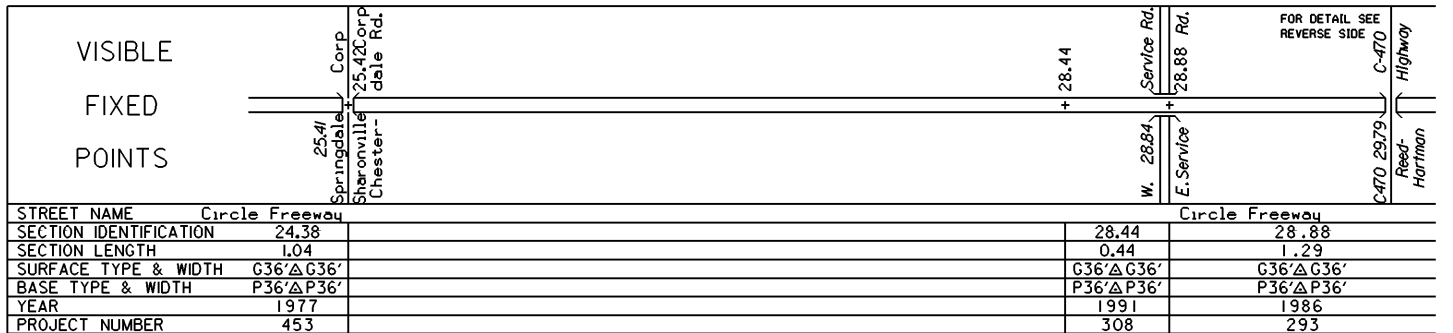

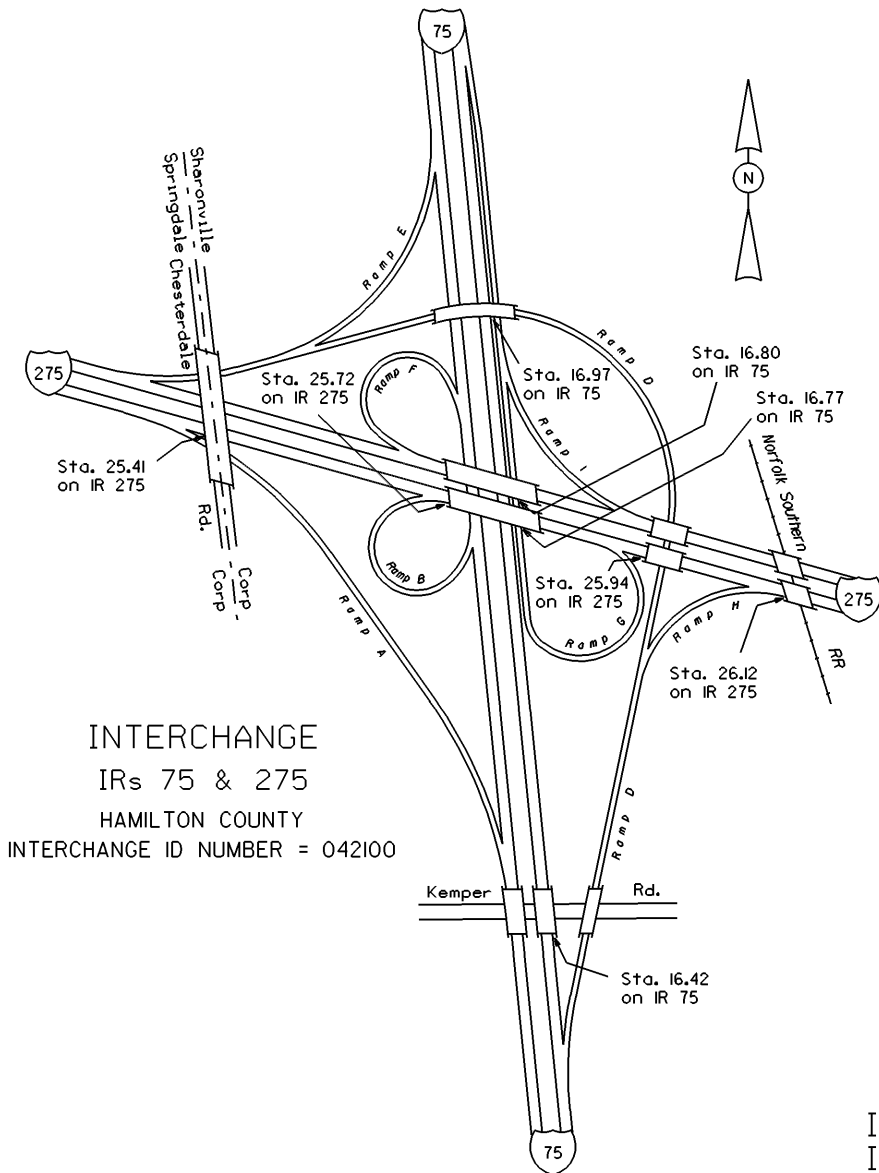

INTERCHANGE
 IRs 75 & 275
 HAMILTON COUNTY
 INTERCHANGE ID NUMBER = 042100

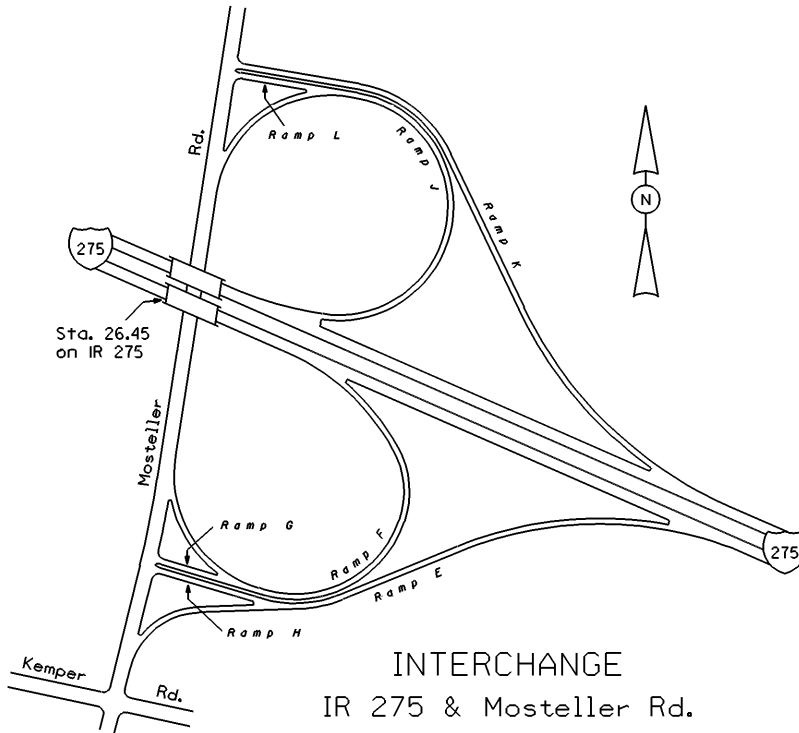

INTERCHANGE
IR 275 & Mosteller Rd.
HAMILTON COUNTY
INTERCHANGE ID NUMBER = 043000



INTERCHANGE
IR 275 & US 42
HAMILTON COUNTY
INTERCHANGE ID NUMBER = 043100

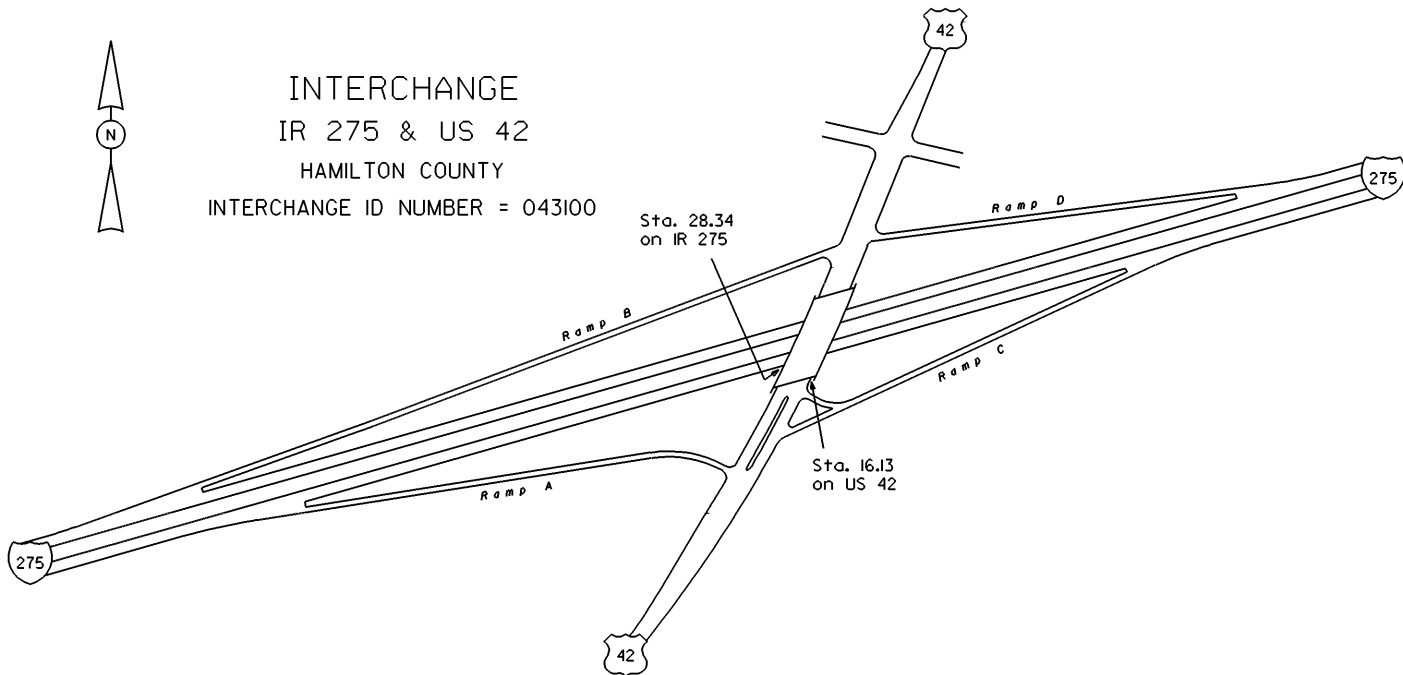

IR 275 SHEET 6 OF 9
US 42 SHEET 6 OF 6

REVISED Jan 2003

INTERCHANGE
IR 275 & Reed
Hartman Hwy. (C-470)
HAMILTON COUNTY
INTERCHANGE ID NUMBER = 043200

Sta. 29.79
on IR 275

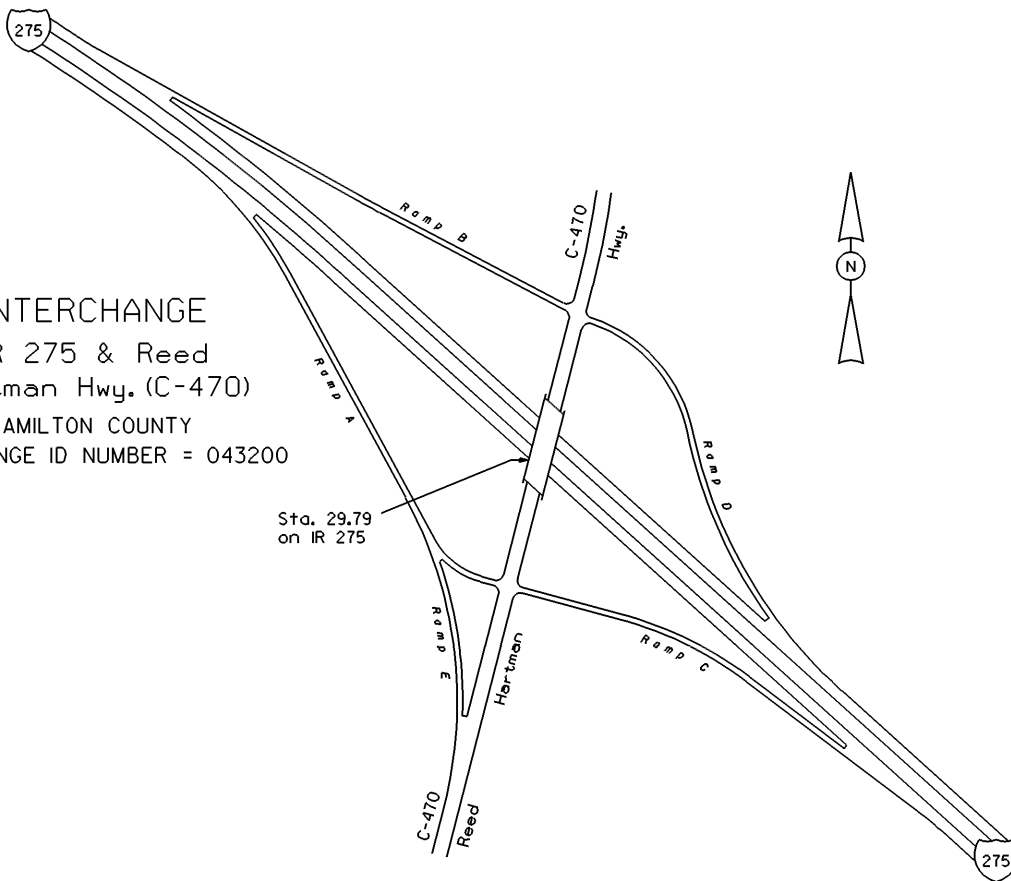

STATE OF OHIO - DEPARTMENT OF TRANSPORTATION
STATE ROUTE SECTIONS ON CONTINUOUS MILEAGE STATIONING

DISTRICT 8
COUNTY HAMILTON
ROUTE IR 275

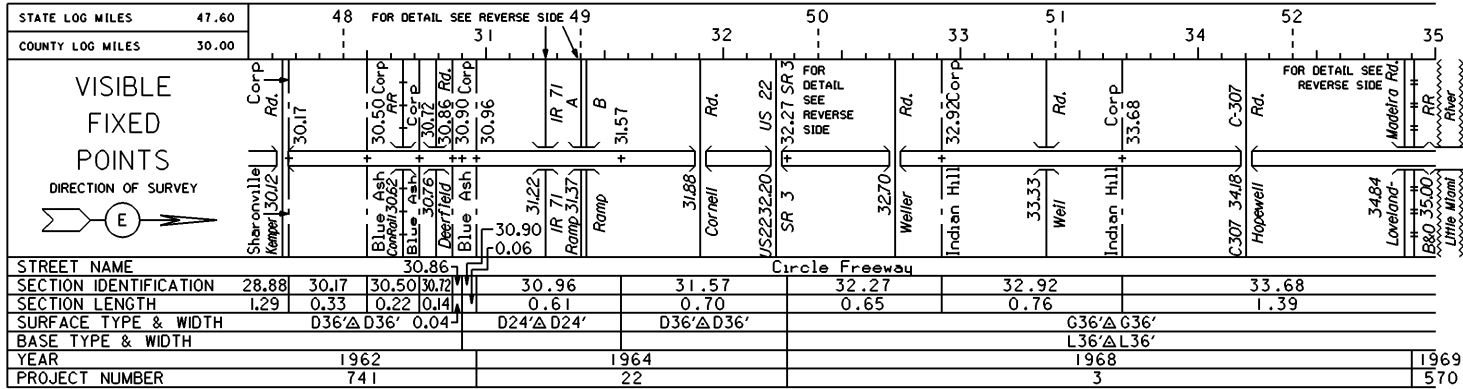

FOR DETAIL SEE REVERSE SIDE PERPETUATION

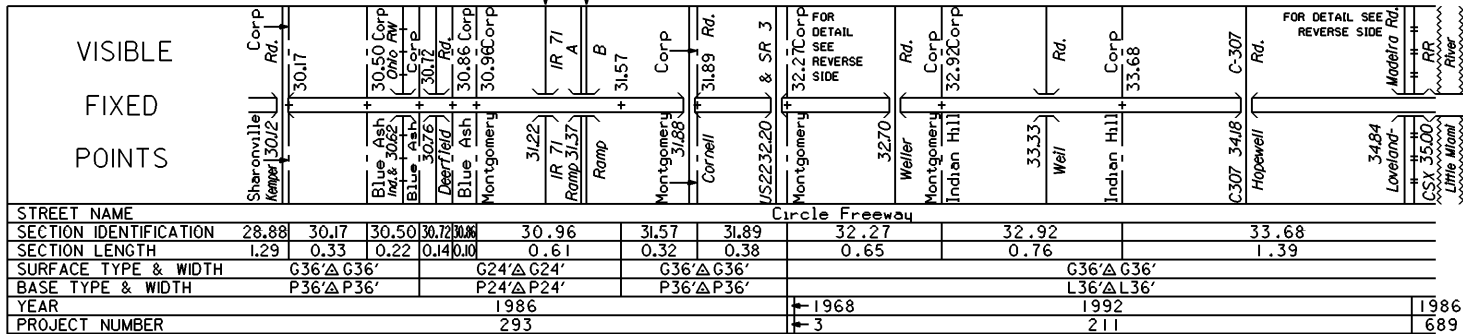

FOR DETAIL SEE REVERSE SIDE

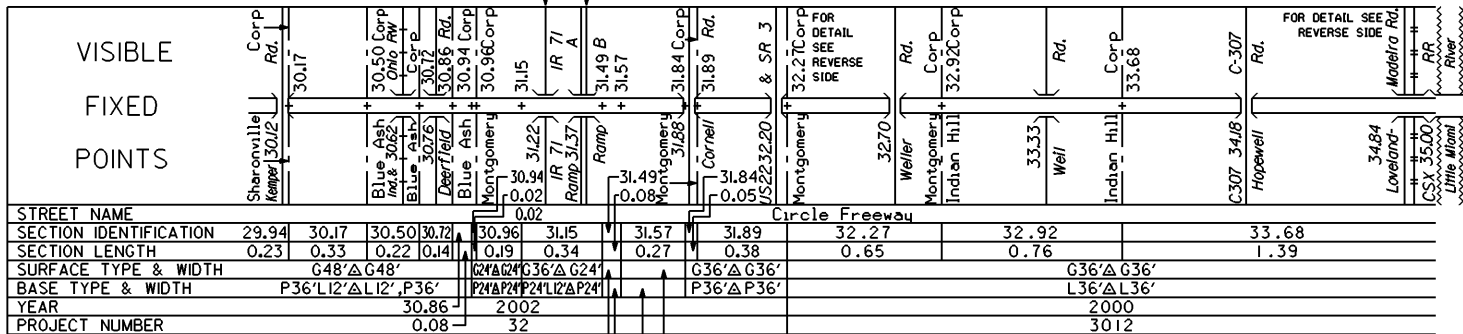

G36'ΔG36', P24'ΔL12'ΔL12', P24', G48'ΔG36', P36'ΔL12'ΔP36'

INTERCHANGE
IR 71 & IR 275
HAMILTON COUNTY

INTERCHANGE ID NUMBER = 039700

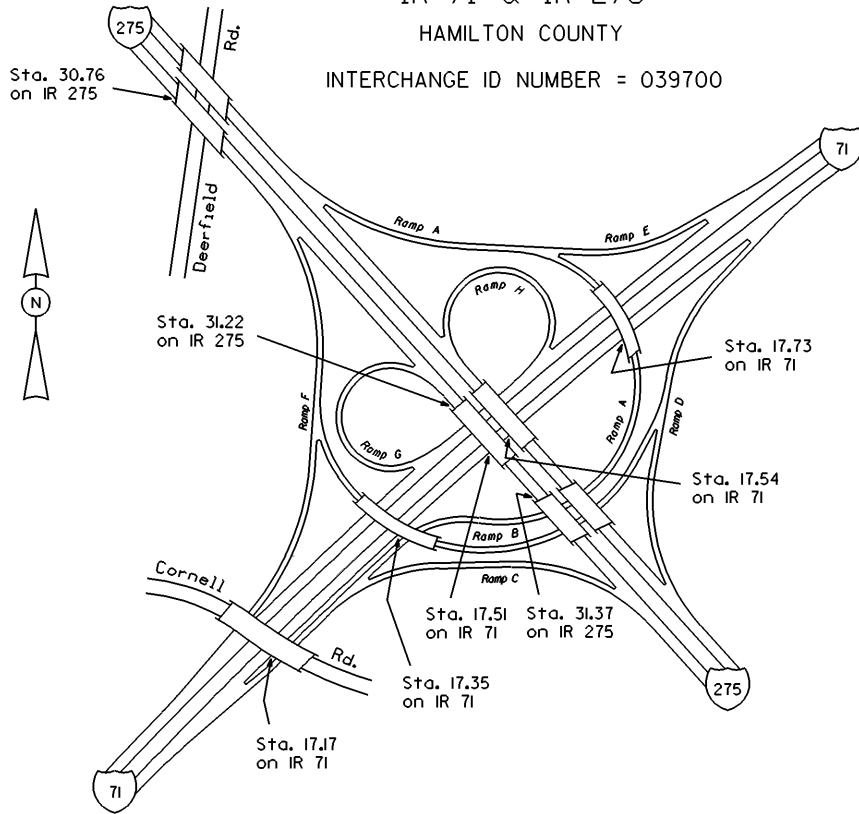

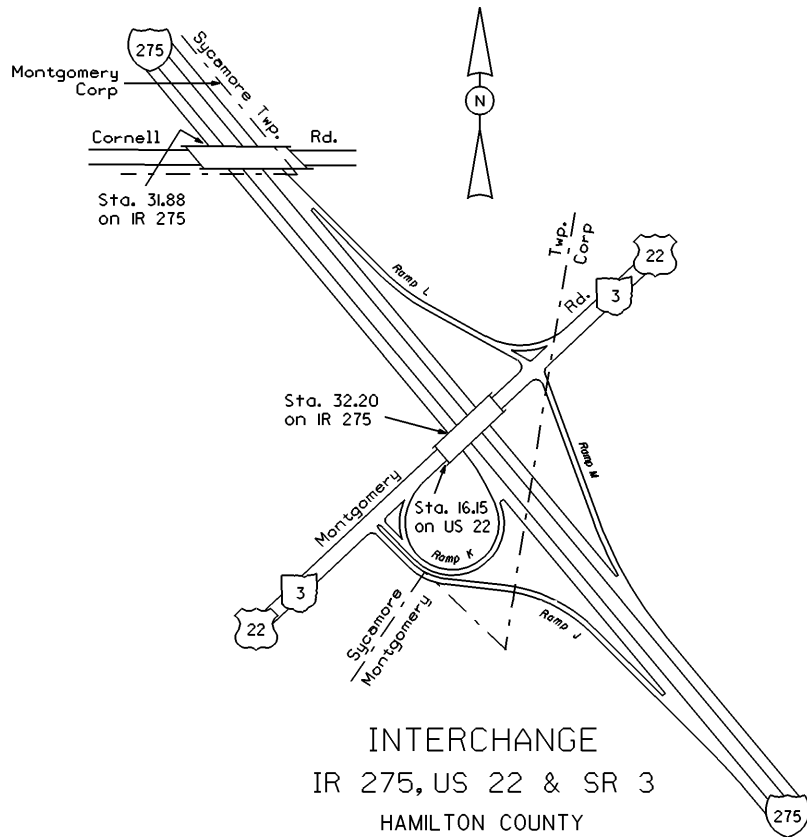

INTERCHANGE
 IR 275, US 22 & SR 3
 HAMILTON COUNTY
 INTERCHANGE ID NUMBER = 043300

INTERCHANGE
IR 275 & Loveland-
Madeira Rd.
HAMILTON COUNTY
INTERCHANGE ID NUMBER = 043400

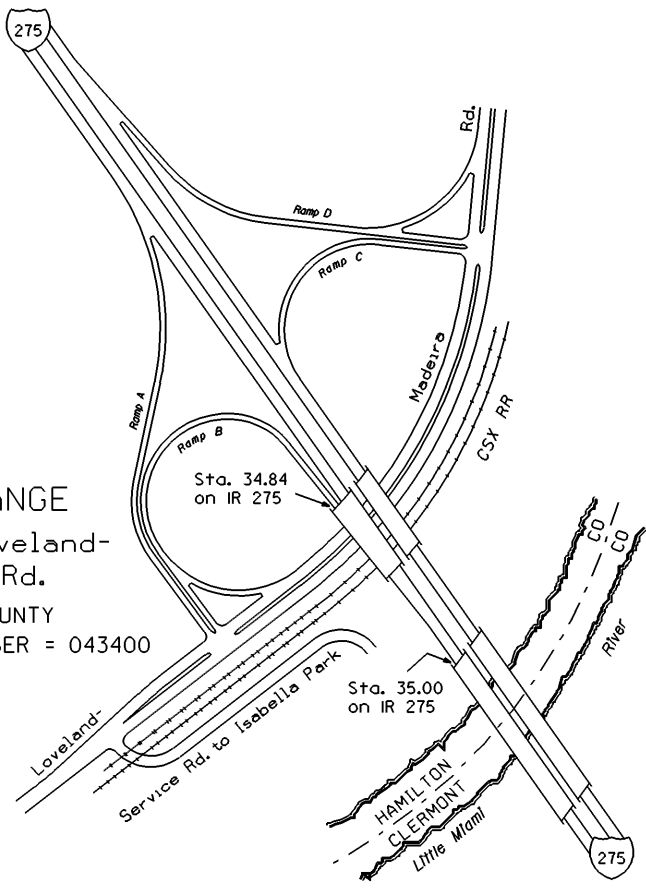
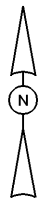

STATE OF OHIO - DEPARTMENT OF TRANSPORTATION

STATE ROUTE SECTIONS ON CONTINUOUS MILEAGE STATIONING

DISTRICT	8
COUNTY	HAMILTON
ROUTE	IR 275

52.67 + 66.55

STATE LOG MILES	52.60	67	36	68	37	69	38	70	39	71	40
COUNTY LOG MILES	35.00										
VISIBLE FIXED POINTS DIRECTION OF SURVEY 	Leave HAM-35.00 Line Wood Rd.	Leave JLTON CO Rd.	C-375 Nordyke Rd. Re-enter HAM CO	C-362 Eight Mile Rd.	C-352 Asbury Rd.	C-365 Five Mile Rd.	C-370 Marbley Rd.	C-354 Burney Lane	FOR DETAIL SEE REVERSE SIDE WB US 52	FOR DETAIL SEE REVERSE SIDE US 52 39.70	C-366 Four Mile Rd. 39.94
Circle Freeway											
SECTION IDENTIFICATION	33.68	35.07			36.58						39.94
SECTION LENGTH	1.39	1.51			3.36						0.71
SURFACE TYPE & WIDTH		G36'ΔG36'		G24'ΔG24'		D24'ΔD24'		D36'ΔD36'			
BASE TYPE & WIDTH		L36'ΔL36'		P24'ΔP24'							
YEAR	1969	1998		1992				1971		1975	
PROJECT NUMBER	570	323		599				166		450	

PERPETUATION

											Not to scale
VISIBLE FIXED POINTS	Leave HAM-35.00 Line Wood Rd.	Leave JLTON CO Rd.	C-375 Nordyke Rd. Re-enter HAM CO	C-362 Eight Mile Rd.	C-352 Asbury Rd.	C-365 Five Mile Rd.	C-370 Marbley Rd.	C-354 Burney Lane	FOR DETAIL SEE REVERSE SIDE WB US 52	FOR DETAIL SEE REVERSE SIDE US 52 39.70	C-366 Four Mile Rd. 39.94
Circle Freeway											
SECTION IDENTIFICATION	33.68	35.07			36.58						39.81 39.94
SECTION LENGTH	1.39	1.51			3.23						0.13 0.71
SURFACE TYPE & WIDTH		G36'ΔG36'		G24'ΔG24'		D24'ΔD24'		G24'ΔG24'			
BASE TYPE & WIDTH		L36'ΔL36'		P24'ΔP24'				P24'ΔP24'			
YEAR	1986	1999		1992				1997		1997	
PROJECT NUMBER	689	6006		599				295		295	

											Not to scale
VISIBLE FIXED POINTS	Leave HAM-35.00 Line Wood Rd.	Leave JLTON CO Rd.	C-375 Nordyke Rd. Re-enter HAM CO	C-362 Eight Mile Rd.	C-352 Asbury Rd.	C-365 Five Mile Rd.	C-370 Marbley Rd.	C-354 Burney Lane	FOR DETAIL SEE REVERSE SIDE WB US 52	FOR DETAIL SEE REVERSE SIDE US 52 39.70	C-366 Four Mile Rd. 39.94
Circle Freeway											
SECTION IDENTIFICATION	33.68	35.07			36.58						37.51
SECTION LENGTH	1.39	1.51			0.93						2.30
SURFACE TYPE & WIDTH		G36'ΔG36'		E36'ΔE36'		D24'ΔD24'					
BASE TYPE & WIDTH		L36'ΔL36'									
YEAR	2000	2005		1992				599			
PROJECT NUMBER	3012	7		599							

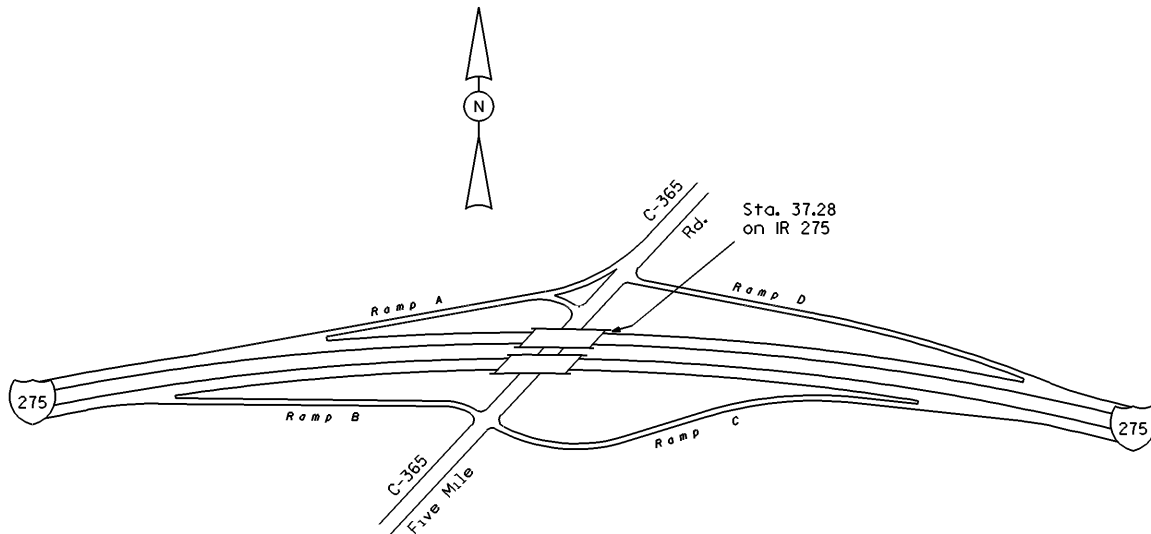

INTERCHANGE
IR 275 & Five
Mile Rd. (C-365)
HAMILTON COUNTY
INTERCHANGE ID NUMBER = 043500

EAST
INTERCHANGE
IR 275 & US 52
HAMILTON COUNTY

INTERCHANGE ID NUMBER = 043600

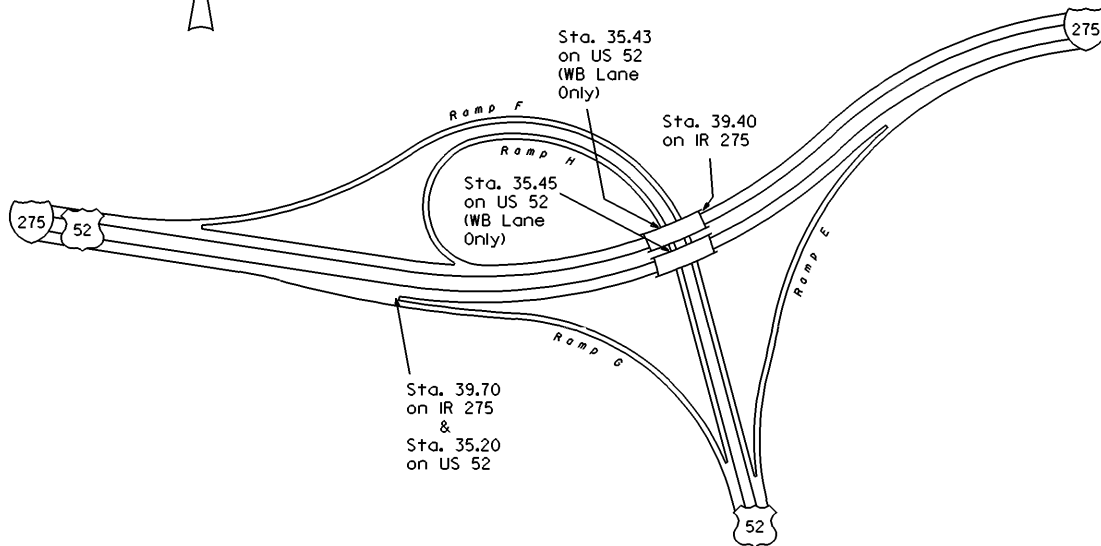

IR 275 SHEET 8 OF 9
US 52 SHEET 6 OF 7

STATE OF OHIO - DEPARTMENT OF TRANSPORTATION

STATE ROUTE SECTIONS ON CONTINUOUS MILEAGE STATIONING

DISTRICT 8
 COUNTY HAMILTON
 ROUTE IR 275

STATE LOG MILES	71.48	40.40	72	40.80	41.20	73	73.08	Total Miles = 55.48
COUNTY LOG MILES	40.00						41.60	42.00
VISIBLE FIXED POINTS DIRECTION OF SURVEY 			(C-382 40.65 Rd. Corp	US 52	FOR DETAIL SEE REVERSE SIDE	US 52	River	Corp LINE 41.60 LINE
			C-382(40.63) Sutton Cincinnati	40.86	41.09 US 52	41.36	Ohio	Cincinnati OHIO KENTUCKY
STREET NAME								
SECTION IDENTIFICATION	39.94				40.65			
SECTION LENGTH	0.71				0.95			
SURFACE TYPE & WIDTH				D36' Δ D36'				
BASE TYPE & WIDTH								
YEAR		1975				1978		
PROJECT NUMBER		450				Kentucky		

PERPETUATION

VISIBLE FIXED POINTS			(C-382 40.65 Rd. Corp	US 52	FOR DETAIL SEE REVERSE SIDE	US 52	River	Corp LINE 41.60 LINE
			C-382(40.63) Sutton Cincinnati	40.86	41.09 US 52	41.36	Ohio	Cincinnati OHIO KENTUCKY
STREET NAME								
SECTION IDENTIFICATION	39.94				40.65		41.36	
SECTION LENGTH	0.71				0.71		0.24	
SURFACE TYPE & WIDTH				C36' Δ C36'			D36' Δ D36'	
BASE TYPE & WIDTH				P36' Δ P36'				
YEAR		1997				1978		
PROJECT NUMBER		295				Kentucky		

VISIBLE								
FIXED								
POINTS								
STREET NAME								
SECTION IDENTIFICATION								
SECTION LENGTH								
SURFACE TYPE & WIDTH								
BASE TYPE & WIDTH								
YEAR								
PROJECT NUMBER								

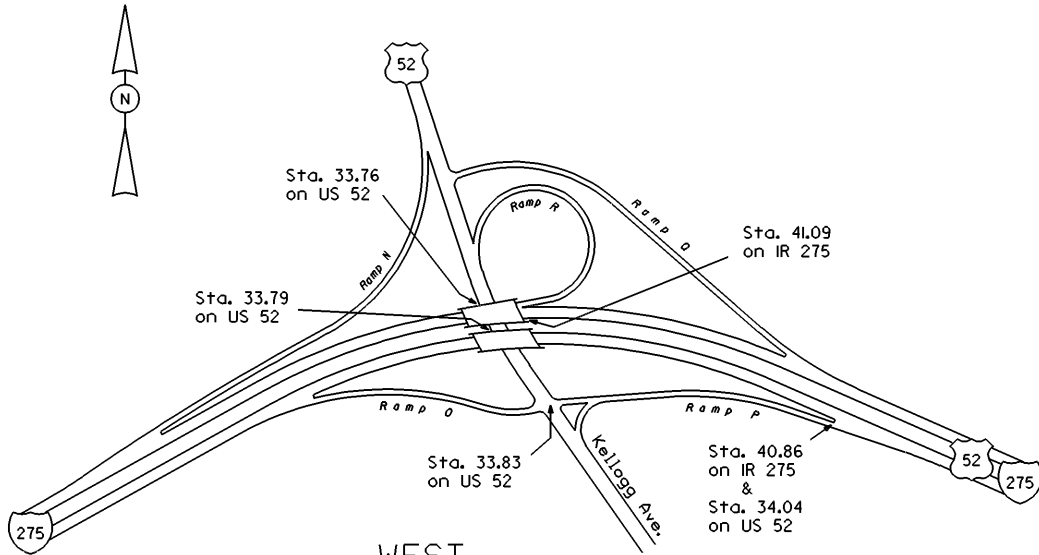

WEST
 INTERCHANGE
 IR 275, US 52 & Kellogg Ave.
 HAMILTON COUNTY
 INTERCHANGE ID NUMBER = 043700