

BEAM SPLICE DETAILS													
BEAM	TYPE	FLANGE PLATES		FLANGE BOLTS			WEB SPLICE		WEIGHT OF SPLICE MAT'RL lbs. #				
		OUTSIDE 2 REQ'D	INSIDE 4 REQ'D	NUM.	N SPA.	PITCH	A	B		C	TYPE	WEB PLATES 2 REQ'D	WEB BOLTS No.
W40X268	B	17 1/2 x 3/8 x 5'-11"	7 x 3/8 x 5'-11"	80	9	3 1/2	2 3/8	3	7 1/8	C	33 x 3/8 x 28 1/4	72	1390
W40X249	B	15 1/2 x 3/8 x 4'-9"	6 x 3/8 x 4'-9"	64	7	3 1/2	2 3/8	2	7 1/8	C	33 x 3/8 x 28 1/4	72	1130
W40X244	B	17 1/2 x 3/8 x 4'-9"	7 x 3/8 x 4'-9"	64	7	3 1/2	2 3/8	3	7 1/8	C	33 x 3/8 x 28 1/4	72	1150
W40X221	B	17 1/2 x 3/8 x 4'-9"	7 x 1/2 x 4'-9"	64	7	3 1/2	2 3/8	3	7 1/8	C	33 x 3/8 x 28 1/4	72	1080
W40X215	B	15 1/2 x 3/8 x 4'-9"	6 x 3/8 x 4'-9"	64	7	3 1/2	2 3/8	2	7 1/8	C	33 x 3/8 x 28 1/4	72	1040
W40X199	B	15 1/2 x 1/2 x 3'-7"	6 x 1/2 x 3'-7"	48	5	3 1/2	2 3/8	2	7 1/8	C	33 x 3/8 x 28 1/4	72	850
W40X192	B	17 1/2 x 3/8 x 3'-7"	7 x 3/8 x 3'-7"	48	5	3 1/2	2 3/8	3	7 1/8	C	33 x 3/8 x 28 1/4	72	840
W40X183	A	11 1/2 x 3/8 x 3'-0"	4 x 3/8 x 3'-0"	40	4	3 1/2	2 3/8	-	7 1/8	B	33 x 3/8 x 21 1/2	54	620
W40X167	A	11 1/2 x 1/2 x 3'-0"	4 x 1/2 x 3'-0"	40	4	3 1/2	2 3/8	-	7 1/8	B	33 x 3/8 x 21 1/2	54	570
W40X149	A	11 1/2 x 3/8 x 2'-5"	4 x 3/8 x 2'-5"	32	3	3 1/2	2 3/8	-	7 1/8	B	33 x 3/8 x 21 1/2	54	500
W36X300	B	16 x 3/4 x 6'-3 1/2"	6 1/2 x 3/4 x 6'-3 1/2"	80	9	3 3/4	2 3/8	2 1/2	7	C	31 x 3/8 x 28 1/4	72	1600
W36X280	B	16 x 3/4 x 6'-3 1/2"	6 1/2 x 3/4 x 6'-3 1/2"	80	9	3 3/4	2 3/8	2 1/2	7	C	31 x 3/8 x 28 1/4	72	1480
W36X260	B	16 x 3/8 x 6'-3 1/2"	6 1/2 x 3/8 x 6'-3 1/2"	80	9	3 3/4	2 1/4	2 1/2	7	C	31 x 3/4 x 28 1/4	72	1380
W36X256	A	12 x 3/8 x 4'-2"	4 1/2 x 3/8 x 4'-2"	56	6	3 1/2	2 3/8	-	7 1/8	C	31 x 3/8 x 28 1/4	72	1090
W36X245	B	16 x 3/8 x 5'-1 1/2"	6 1/2 x 3/8 x 5'-1 1/2"	64	7	3 3/4	2 3/8	2 1/2	6 1/8	C	31 x 3/4 x 28 1/4	72	1170
W36X232	A	12 x 1/8 x 4'-2"	4 1/2 x 1/8 x 4'-2"	56	6	3 1/2	2 3/8	-	7 1/8	C	31 x 3/8 x 28 1/4	72	1010
W36X230	B	16 x 3/8 x 5'-1 1/2"	6 1/2 x 3/8 x 5'-1 1/2"	64	7	3 3/4	2 3/8	2 1/2	6 1/8	C	31 x 3/8 x 28 1/4	72	1100
W36X210	A	12 x 3/8 x 3'-7"	4 1/2 x 3/8 x 3'-7"	48	5	3 1/2	2 3/8	-	7 1/8	C	31 x 3/8 x 28 1/4	72	910
W36X194	A	12 x 3/8 x 3'-0"	4 1/2 x 3/8 x 3'-0"	40	4	3 1/2	2 3/8	-	6 1/8	C	31 x 3/4 x 28 1/4	72	780
W36X182	A	12 x 3/8 x 3'-0"	4 1/2 x 3/8 x 3'-0"	40	4	3 1/2	2 3/8	-	6 1/8	C	31 x 3/8 x 28 1/4	72	740
W36X170	A	12 x 1/2 x 3'-0"	4 1/2 x 1/2 x 3'-0"	40	4	3 1/2	2 3/8	-	6 1/8	B	31 x 3/8 x 21 1/2	54	570
W36X160	A	12 x 1/2 x 2'-5"	4 1/2 x 1/2 x 2'-5"	32	3	3 1/2	2 3/8	-	6 1/8	B	31 x 3/8 x 21 1/2	54	510
W36X150	A	11 7/8 x 1/2 x 2'-5"	4 1/2 x 1/2 x 2'-5"	32	3	3 1/2	2 3/8	-	6 1/8	B	31 x 3/8 x 21 1/2	54	510
W36X135	A	11 7/8 x 3/8 x 2'-5"	4 1/2 x 3/8 x 2'-5"	32	3	3 1/2	2 3/8	-	6 1/8	B	31 x 1/2 x 21 1/2	54	460
W33X263	B	15 1/2 x 3/8 x 5'-11"	6 1/2 x 3/8 x 5'-11"	80	9	3 1/2	2 3/8	2 1/2	6 3/8	C	29 3/8 x 28 1/4	64	1350
W33X241	B	15 1/2 x 3/8 x 4'-9"	6 1/2 x 3/8 x 4'-9"	64	7	3 1/2	2 1/4	2 1/2	6 3/8	C	29 3/8 x 28 1/4	64	1100
W33X221	B	15 1/2 x 3/8 x 4'-9"	6 1/2 x 3/8 x 4'-9"	64	7	3 1/2	2 3/8	2 1/2	6 3/8	C	29 3/8 x 28 1/4	64	1010
W33X201	B	15 1/2 x 1/2 x 4'-9"	6 1/2 x 1/2 x 4'-9"	64	7	3 1/2	2 1/4	2 1/2	6 1/4	C	29 3/8 x 28 1/4	64	980
W33X169	A	11 x 3/8 x 3'-0"	4 1/2 x 3/8 x 3'-0"	40	4	3 1/2	2 3/8	-	6 3/8	B	29 3/8 x 21 1/2	48	570
W33X152	A	11 x 1/2 x 2'-5"	4 1/2 x 1/2 x 2'-5"	32	3	3 1/2	2 1/8	-	6 3/8	B	29 3/8 x 21 1/2	48	470
W33X141	A	11 x 1/2 x 2'-5"	4 1/2 x 1/2 x 2'-5"	32	3	3 1/2	2 1/8	-	6 3/8	B	29 3/8 x 1/2 x 21 1/2	48	460
W33X130	A	11 x 3/8 x 2'-5"	4 1/2 x 3/8 x 2'-5"	32	3	3 1/2	2 1/8	-	6 3/8	B	29 3/8 x 1/2 x 21 1/2	48	440
W33X118	A	11 x 3/8 x 1'-10"	4 1/2 x 3/8 x 1'-10"	24	2	3 1/2	2 1/8	-	6 3/8	B	29 3/8 x 1/2 x 21 1/2	48	380
W30X211	B	15 x 3/8 x 4'-9"	6 x 3/8 x 4'-9"	64	7	3 1/2	2 3/8	2	6 1/4	C	26 1/2 x 28 1/4	56	990
W30X191	B	15 x 1/2 x 3'-7"	6 x 1/2 x 3'-7"	48	5	3 1/2	2 1/8	2	6 1/8	C	26 1/2 x 28 1/4	56	780
W30X173	B	14 7/8 x 1/2 x 3'-7"	6 x 1/2 x 3'-7"	48	5	3 1/2	2 1/8	2	6 1/8	C	26 1/2 x 28 1/4	56	730
W30X148	A	10 x 3/8 x 2'-5"	4 x 3/8 x 2'-5"	32	3	3 1/2	2 1/4	-	6	B	26 1/2 x 21 1/2	42	460
W30X132	A	10 x 1/2 x 2'-5"	4 x 1/2 x 2'-5"	32	3	3 1/2	2 3/8	-	6 1/8	B	26 1/2 x 1/2 x 21 1/2	42	420
W30X124	A	10 x 1/8 x 2'-5"	4 x 1/8 x 2'-5"	32	3	3 1/2	2 1/4	-	6	B	26 1/2 x 1/2 x 21 1/2	42	410
W30X116	A	10 x 1/8 x 1'-10"	4 x 1/8 x 1'-10"	24	2	3 1/2	2 1/4	-	6	B	26 1/2 x 1/2 x 21 1/2	42	360
W30X108	A	10 x 3/8 x 1'-10"	4 x 3/8 x 1'-10"	24	2	3 1/2	2 1/4	-	6	B	26 1/2 x 1/2 x 21 1/2	42	350
W30X99	A	10 x 3/8 x 1'-10"	4 x 3/8 x 1'-10"	24	2	3 1/2	2 1/4	-	6	B	26 1/2 x 1/8 x 21 1/2	42	330
W30X90	A	10 x 3/8 x 1'-10"	4 x 3/8 x 1'-10"	24	2	3 1/2	2 3/8	-	6	A	26 1/2 x 3/8 x 14 3/4	28	250
W27X194	A	14 x 3/8 x 4'-2"	5 1/2 x 3/8 x 4'-2"	56	6	3 1/2	3 1/4	-	7 1/2	C	24 x 28 1/4	48	850
W27X178	A	14 x 3/8 x 3'-7"	5 1/2 x 3/8 x 3'-7"	48	5	3 1/2	3 1/4	-	7 1/2	C	24 x 28 1/4	48	730
W27X161	A	14 x 1/2 x 3'-0"	5 1/2 x 1/2 x 3'-0"	40	4	3 1/2	3 1/4	-	7 1/2	C	24 x 28 1/4	48	630
W27X146	A	13 7/8 x 1/8 x 3'-0"	5 1/2 x 1/8 x 3'-0"	40	4	3 1/2	3 1/4	-	7 1/2	B	24 x 1/2 x 21 1/2	36	490
W27X129	A	10 x 1/2 x 2'-5"	4 x 1/2 x 2'-5"	32	3	3 1/2	2 1/8	-	5 1/8	B	24 x 1/2 x 21 1/2	36	400
W27X114	A	10 x 1/2 x 1'-10"	4 x 1/2 x 1'-10"	24	2	3 1/2	2 1/8	-	5 1/8	B	24 x 1/2 x 21 1/2	36	340
W27X102	A	10 x 3/8 x 1'-10"	4 x 3/8 x 1'-10"	24	2	3 1/2	2 1/8	-	5 1/8	B	24 x 1/8 x 21 1/2	36	310
W27X94	A	9 7/8 x 3/8 x 1'-10"	4 x 3/8 x 1'-10"	24	2	3 1/2	2 1/8	-	5 1/8	B	24 x 7/16 x 21 1/2	36	300
W27X84	A	9 7/8 x 3/8 x 1'-10"	4 x 3/8 x 1'-10"	24	2	3 1/2	2 1/8	-	5 1/8	A	24 x 3/8 x 14 3/4	24	230
W24X162	A	12 1/2 x 3/8 x 3'-7"	5 x 3/8 x 3'-7"	48	5	3 1/2	2 3/8	-	7 1/8	C	20 7/8 x 28 1/4	48	690
W24X146	A	12 1/2 x 1/2 x 3'-0"	5 x 1/2 x 3'-0"	40	4	3 1/2	2 3/8	-	7 1/8	B	20 7/8 x 21 1/2	36	510

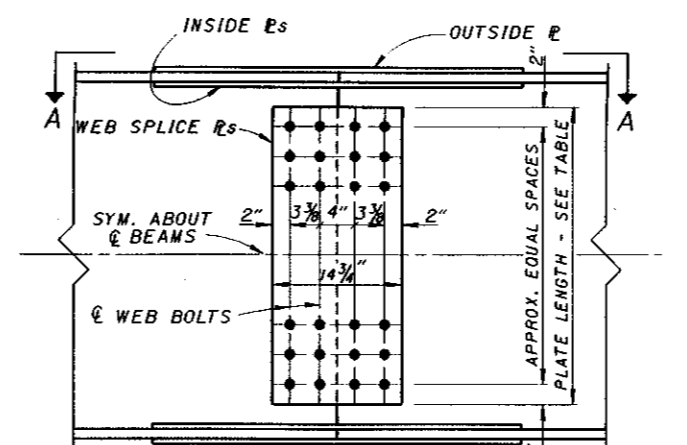

BEAM SPLICE DETAIL
WEB SPLICE - TYPE A

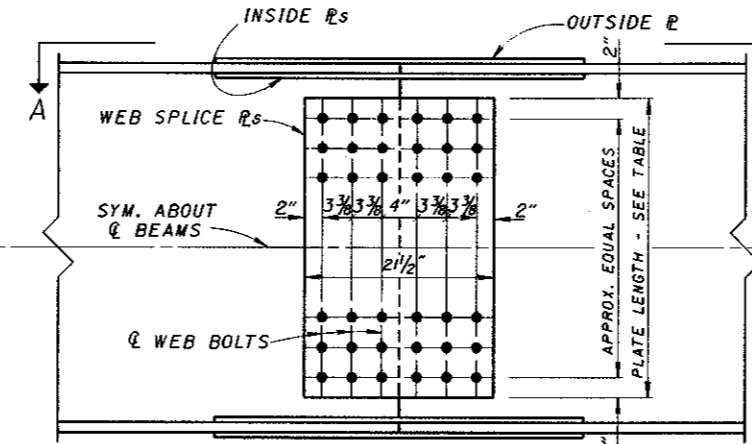

BEAM SPLICE DETAIL
WEB SPLICE - TYPE B

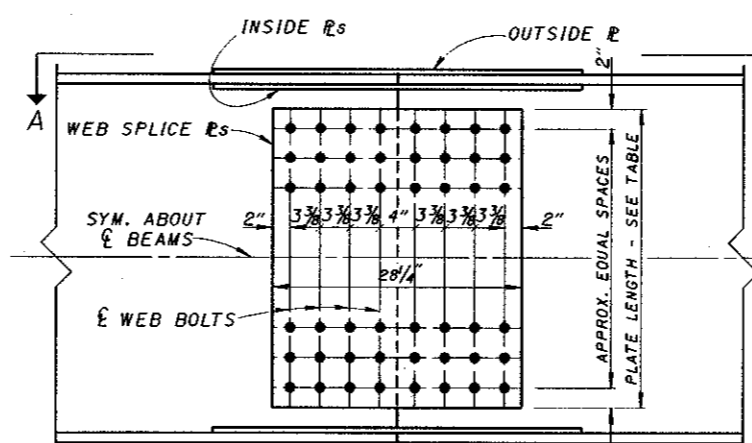

BEAM SPLICE DETAIL
WEB SPLICE - TYPE C

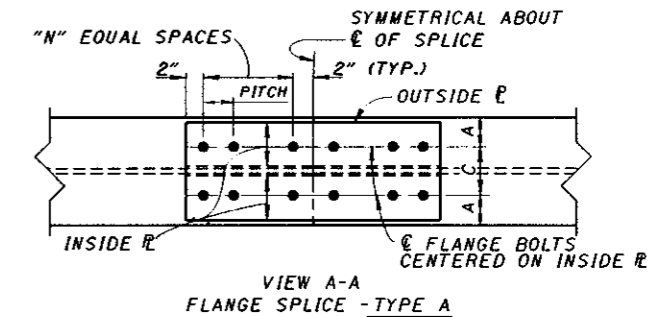

VIEW A-A
FLANGE SPLICE - TYPE A

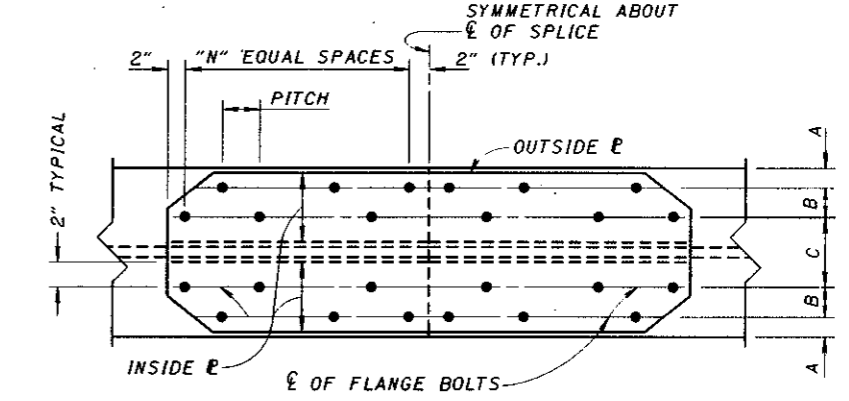

VIEW A-A
FLANGE SPLICE - TYPE B

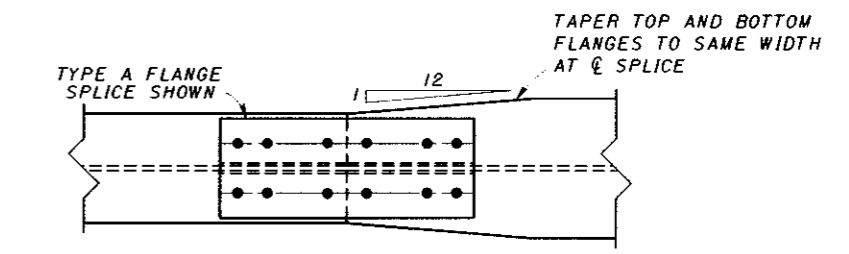

VIEW A-A
SPLICE DETAIL FOR BEAMS HAVING
DIFFERENT FLANGE WIDTHS

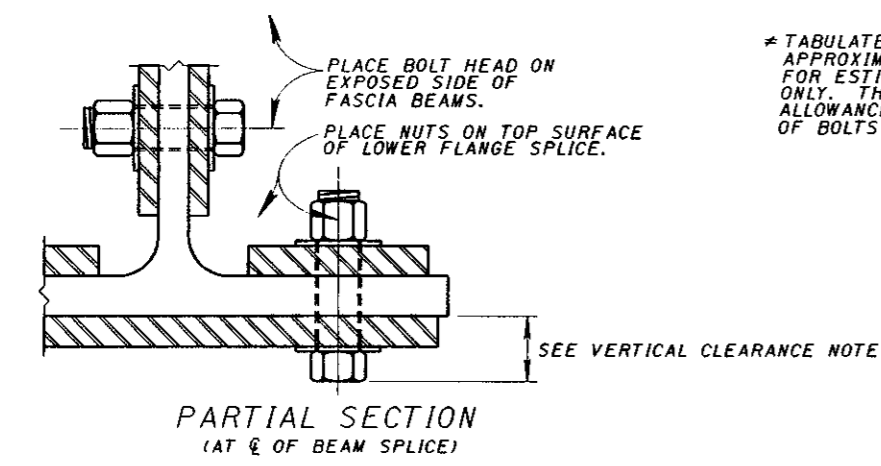

PARTIAL SECTION
(AT C OF BEAM SPLICE)

* TABULATED WEIGHTS ARE APPROXIMATE AND ARE FOR ESTIMATING PURPOSES ONLY. THEY INCLUDE AN ALLOWANCE FOR WEIGHT OF BOLTS AND WASHERS.

NOTE: ALL SHAPES AND PLATES SHALL BE DESIGNATED (CVN), AND SHALL MEET SPECIFIED MINIMUM NOTCH TOUGHNESS REQUIREMENTS AS SPECIFIED IN 711.01 OF CMS.
NOTE: ALL FASTENERS ARE 1/8" DIAMETER HIGH STRENGTH BOLTS, ASTM A-325